

# KOVOVÝ NÁBYTOK METAL FURNITURE

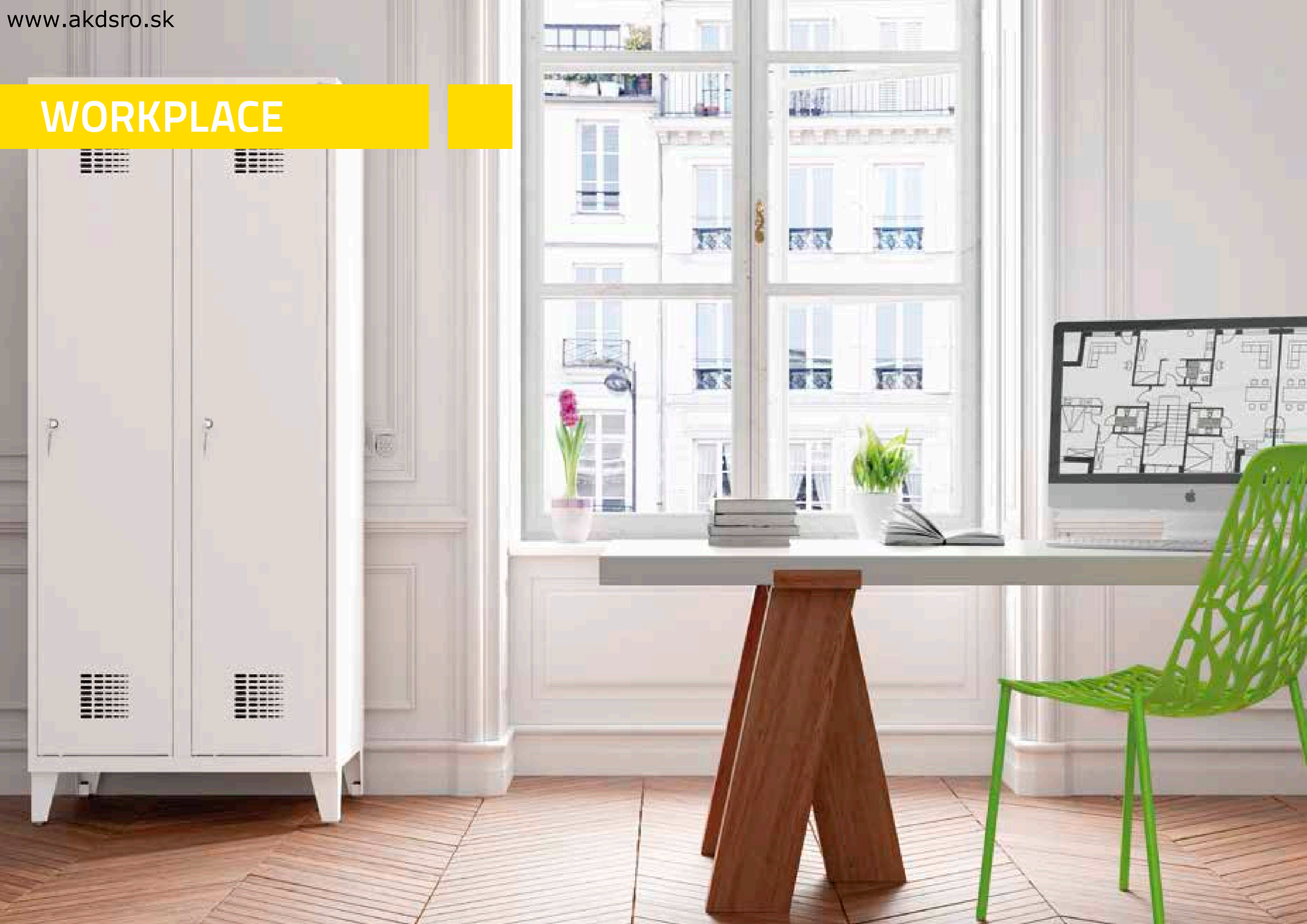

[www.akdsro.sk](http://www.akdsro.sk)

# WORKPLACE



# LIVING ROOM



# LIBRARY





# TEENAGER'S ROOM

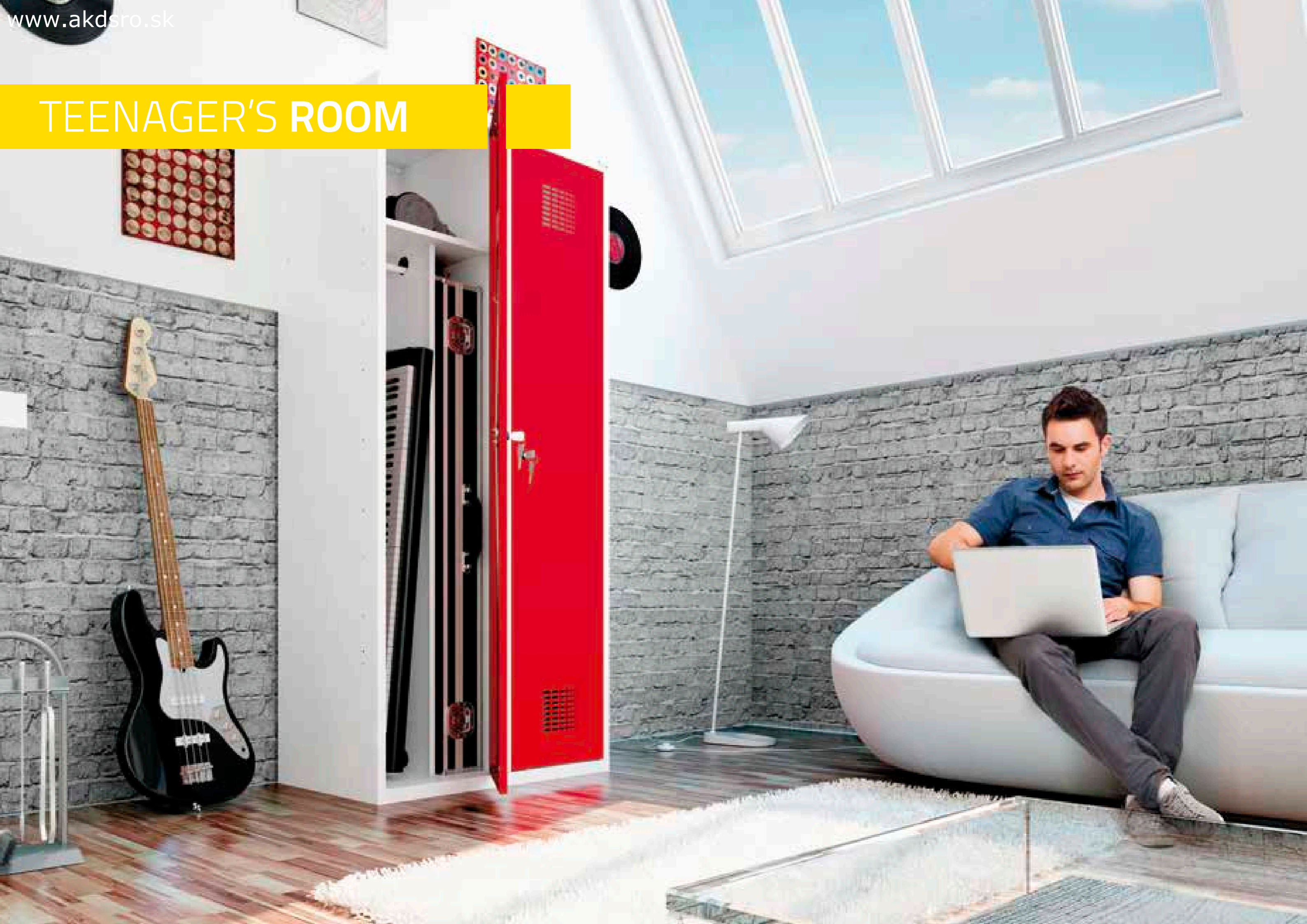

# KITCHEN



# BATHROOM



# CHILDREN'S ROOM



# ATELIER

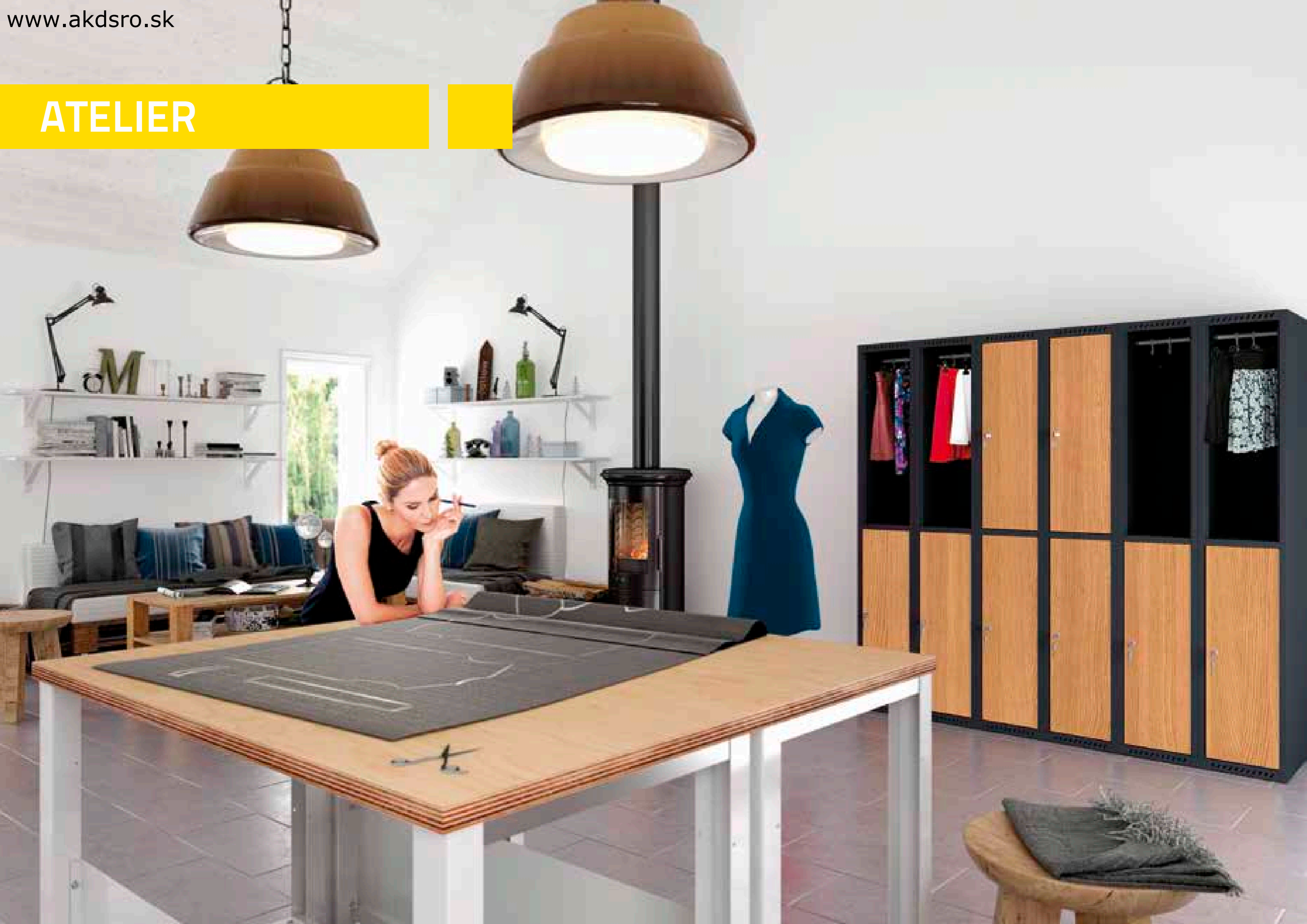



# TEENAGER'S BEDROOM





# TEENAGER'S ROOM



# ALLERGY FRIENDLY ROOM



- experience:  
„we know all about steel“



# METAL FURNITURE

## CONTENTS

---

	Office furniture	52	
	Social furniture	106	
	Medical furniture	186	
	Workshop furniture	210	
	Movable shelving systems	252	

# OFFICE FURNITURE

*Furniture  
you can depend on*



# OFFICE FURNITURE

## CONTENTS

Cabinets with wing doors	56
Cabinets with retractable doors	62
Cabinets with shutter doors	64
Cabinets with sliding doors	68
RZ cabinets without doors	70
Additional equipment	72
SKB Cabinets for documents and files	76
SAM W Reinforced cabinets for documents SZK 301 OG Filing cabinets with increased fire resistance	78
SZK Filing cabinets	80
SCD Cabinets for CD's	86
SRM Drawing cabinets	88
E-class classroom furnishing	90
SKT Cabinets for catalogues	92
RMB Library racks	94
Office desks	96
Desk connectors	98
Mobile pedestals	100
Table tops	102
Tower pedestals	104

Metal office furniture allows for modern, functional and practical equipment of a workplace. Metal optimally meets the requirements in terms of design, quality, functionality and durability. Comfort, functionality, ergonomics – these are the features of metal office furniture which customers appreciate most.

In the case of individual needs we are able to offer a wide range of solutions prepared according to your expectations.

Our offer includes:

- Filing cabinets with wing, shutter, retractable and sliding doors,
- Reinforced cabinets for documents,
- Filing cabinets,
- Drawing cabinets,
- Library racks,
- Desks,
- Tables.

There are also versions of a wardrobe – filing locker, with a compartment, closed cabinets.

**Cabinet with a wardrobe and filing compartment** section with a bar and hooks for clothes, as well as four shelves for documents: 1 long shelf with a pull-out hanger and 3 short shelves adjustable every 25 mm ± 3 positions from the center position, fixed to the partition wall placed in the middle of the cabinet.

**Cabinet with a storage box** – SBM 204, 213, two door storage box with a partition wall, welded, lockable with a single-point cylinder lock and 3 shelves adjustable every 25 mm, ± 3 positions from the center position.

	Hanging file sizes		For self-assembly		Non-combustible
	Sizes		Adjustable shelves		30 kg drawer load capacity
	The drawer on full extension ball bearing slides		Shelves adjustable in increments		40 kg drawer load capacity
	Stackable		Possibility of mounting to a wall		50 kg drawer load capacity
	Anti-tilt system		On wheels		Possibility of removing drawers
	Binder		Shelves adjusted to hanging files		Elements for leveling
	Center lock		25 kg shelf load capacity		180° door swing angle
	CD-ROM		40 kg shelf load capacity		110° door swing angle
	Adjustable feet's height		60 kg shelf load capacity		
	Possibility of hanging clothes		80 kg shelf load capacity		

# OFFICE FURNITURE

## SBM OFFICE CABINETS WITH WING DOORS

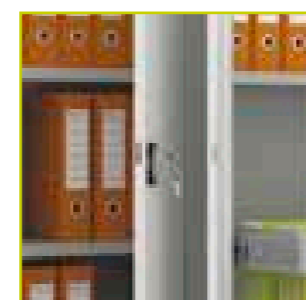

2-point locking door handle

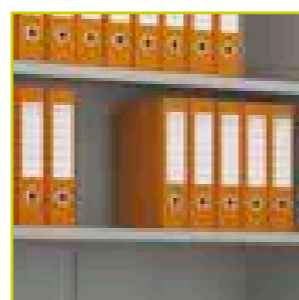

adjustable shelves



maximum load capacity – 60 kg (optionally 80 kg)

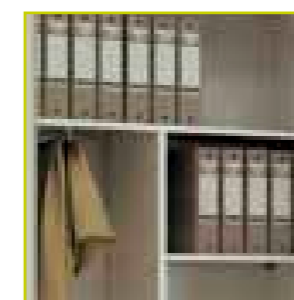

wardrobe-filing cabinet available

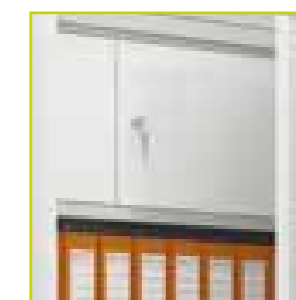

storage locker available



top cabinets available

Filing cabinets with wing doors are the most popular and frequently chosen office cabinets. In addition, their price competitiveness makes them one of our top sellers.

Office cabinets are of comprehensive use thanks to varied possibilities of their internal equipment: shelves adjustable every 25 mm, extended shelves, full and frame drawers.

The cabinets' standard equipment are shelves adjustable every 25 mm:

- small cabinets – Sbm 101, 102, 103, 107 - 2 shelves adjustable every 25 mm ± 4 positions from the center position,
- high cabinets – Sbm 201, 202, 203, 212 – 4 shelves adjustable every 25 mm ± 3 positions from the center position.

Standard shelf's load capacity – 60 kg.  
Optional shelf's load capacity – 80 kg.

### STANDARD EQUIPMENT:

- 2-point locking door handle (top and bottom of the door),
- adjustable shelves,
- maximum shelf's load capacity – 60 kg (optionally 80 kg),
- wardrobe-filing cabinet available,
- storage locker available,
- top cabinets available.





# OFFICE FURNITURE

## SBM OFFICE CABINETS WITH WING DOORS

Doors with hidden hinges. Door handle with security lock. Locking in 2 points (top and bottom).

### CABINETS' ADVANTAGES:

- extensive equipment as standard,
- 16 RAL colours without extra charge,
- various sizes and equipment,
- adjustable shelves,
- various types of cabinets,
- various price levels.



### CABINETS' ADVANTAGES

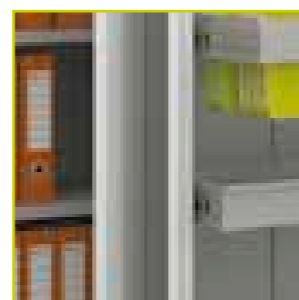

extensive equipment  
as standard



16 RAL colours without  
extra charge

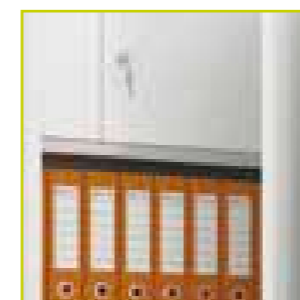

various sizes and equipment

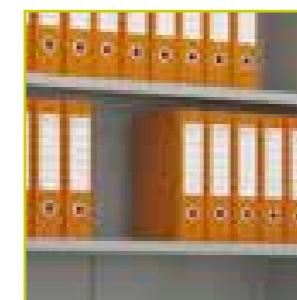

adjustable shelves

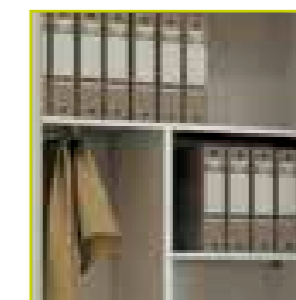

various types of cabinets



various price levels



# OFFICE FURNITURE

## SBM OFFICE CABINETS WITH WING DOORS

We offer a wide range of top cabinets. The width of top cabinets is adjusted to the width of standard cabinets. Available top cabinets:

- 465 mm high – for 2 low rows of files,
- 810 mm high – for 2 rows of binders.

Top cabinets have one shelf adjustable every 25 mm ± 3 positions from the center position.

Designation	SBM 101 M	SBM 102 M	SBM 103 M	SBM 107 M	SBM 201 M	SBM 202 M	SBM 203 M	SBM 212 M
Code	SBM 01022203	SBM 02022303	SBM 03022303	SBM 04022303	SBM 01032204	SBM 02032304	SBM 03032304	SBM 04032304
Height (mm)	1040		1040		1990			
Width (mm)	600	800	1000	1200	600	800	1000	1200
Depth (mm)	435		435					
Cabinet's capacity	2 rows of binders		2 rows of binders		5 rows of binders			
Number of shelves	2		2		4			

Designation	SBM 204 M	SBM 213 M	SBM 206 M	SBM 215 M
Code	SBM 03032305	SBM 04032305	SBM 03032306	SBM 04032306
Height (mm)	1990		1990	
Width (mm)	1000	1200	1000	1200
Depth (mm)	435		435	
Cabinet's capacity	4 rows of binders + locker		1 row of binders + 4 in halves	
Number of shelves	3		4 shelves + wardrobe compartment	

For an extra charge, cabinets can be equipped with leveling feet, screwed to the bottom. They are regulated from the inside of the cabinet.

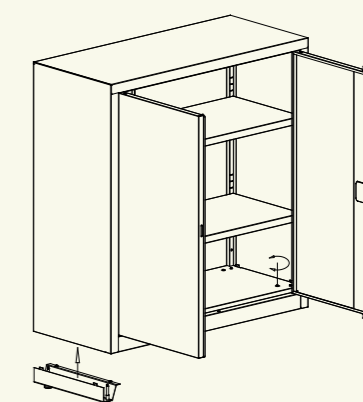

Designation	SBM 401 M	SBM 402 M	SBM 403 M	SBM 405 M	SBM 801 M	SBM 802 M	SBM 803 M	SBM 804 M
Code	SBM 01012202	SBM 02012302	SBM 03012302	SBM 04012302	SBM 01122202	SBM 02122302	SBM 03122302	SBM 04122302
Height (mm)	465		465		810			
Width (mm)	600	800	1000	1200	600	800	1000	1200
Depth (mm)	435		435					
Cabinet's capacity	2 low rows		2 low rows		2 rows of binders			
Number of shelves	1		1		1			

# OFFICE FURNITURE

## SBM OFFICE CABINETS WITH RETRACTABLE DOORS

The office cabinet with retractable doors significantly reduces the space needed to open the cabinet. The doors slide into sides of the cabinet. 2-point locking door handle (top and bottom of the door).

**STANDARD EQUIPMENT:**

**Sbm 210** - standard equipment: 4 shelves adjustable every 25 mm ± 3 positions from the center position, **Sbm 211** - the two-door storage locker, welded, lockable with single-point cylinder lock, 3 adjustable shelves.

**ADDITIONAL EQUIPMENT:**

Extendable shelf, full and frame drawer.

Maximum load capacity of shelf, drawer and frame drawer in cabinets with retractable doors is 40 kg.

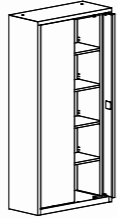
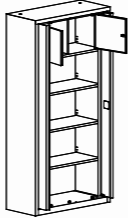

### TECHNICAL SPECIFICATION

		
Designation	SBM 210 M	SBM 211 M
Code	SBMC 03032804	SBMC 03032805
Height (mm)	1990	
Width (mm)	1000	
Depth (mm)	435	
Cabinet's capacity	5 rows of binders	4 rows of binders + locker
Number of shelves	4	3



# OFFICE FURNITURE

## SBM OFFICE CABINETS WITH SHUTTER DOORS

Office cabinets thanks to elegant, silent and lightly sliding shutter doors are very popular in offices. Their functionality and a wide range of additional accessories ensure high flexibility in interior design. Shutter doors are made from plastic slats, with a latch lock with 2 keys. Maximum standard shelf's load capacity is 40 kg.

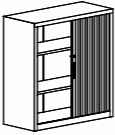
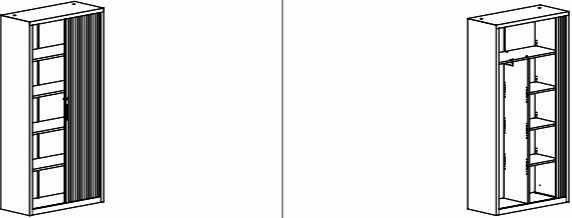
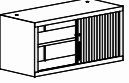

### TECHNICAL SPECIFICATION

								
Designation	SBM 105 M	SBM 109 M	SBM 208 M	SBM 217 M	SBM 218 M	SBM 219 M	top mounted cabinet SBM 404 M	top mounted cabinet SBM 406 M
Code	SBMZ 03021703	SBMZ 04021703	SBMZ 03031704	SBMZ 04031704	SBMZ 03031706	SBMZ 04031706	SBMZ 03011702	SBMZ 04011702
Height (mm)	1040		1990				465	
Width (mm)	1000	1200	1000	1200	1000	1200	1000	1200
Depth (mm)	435		435					
Cabinet's capacity	2 rows of binders		5 rows of binders		1 row of binders + 4 in halves		2 low rows	
Number of shelves	2		4		4 shelves + wardrobe compartment		1	

# OFFICE FURNITURE

## SBM OFFICE CABINETS WITH SHUTTER DOORS

### STANDARD

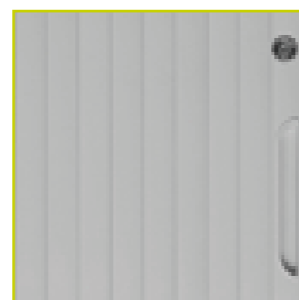

Grey



Cream



Black

### EXTRA CHARGE

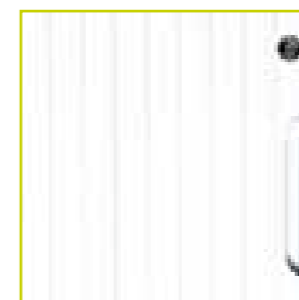

White



Silver



Beech

The cabinet has shelves adjustable every 25 mm:

- **Sbm 208, 217, 218, 219:** 4 shelves adjustable  $\pm 3$  positions from the center position,
- **Sbm 105, 109:** 2 shelves adjustable  $\pm 4$  positions from the center position,
- **Sbm 701:** 2 shelves adjustable  $\pm 3$  positions from the center position,
- **Sbm 404, 406:** 1 shelf  $\pm 3$  positions from the center position.

Maximum load capacity per shelf, extended shelf, drawer and frame drawer in cabinets with shutter doors is 40 kg.



# OFFICE FURNITURE

## SBM OFFICE CABINETS WITH SLIDING DOORS



Office cabinets with sliding doors do not require any additional space to open, and their aesthetic value and reliability are appreciated by their users.

**Sbm 222, 220, 221** – 4 shelves adjustable every 25 mm.  
**Sbm 112, 110, 111** – 2 shelves adjustable every 25 mm.

Cabinets are equipped with a cylindric lock and a door handle.

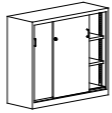
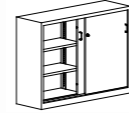

### TECHNICAL SPECIFICATION

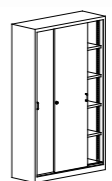
						
Designation	SBM 112	SBM 110	SBM 111	SBM 222	SBM 220	SBM 221
Code	SBMP 03020803	SBMP 4020803	SBMP 05020804	SBMP 03030804	SBMP 04030804	SBMP 05030820
Height (mm)	1040		1040	1990		
Width (mm)	1000	1200	1400	1000	1200	1400
Depth (mm)	435		435			
Cabinet's capacity	2 rows of binders		2 rows of binders	5 rows of binders		
Number of shelves	2		4 – 2 shelves on each side of the partition wall	4	8 – 4 shelves on each side of the partition wall	



# OFFICE FURNITURE

## RZ CABINETS WITHOUT DOORS

Cabinets without doors are very practical and popular in various kinds of offices. They combine the strength of metal office cabinets and easy access to stored documents.

Racks equipped with shelves:

- small cabinets – RZ 101, 102, 103, 107 - 2 shelves adjustable every 25 mm ± 4 positions from the centre position,
- high cabinets – RZ 201, 202, 203, 212 - 4 shelves adjustable every 25 mm ± 3 positions from the centre position.

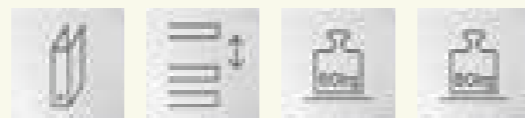

### TECHNICAL SPECIFICATION

Designation	RZ 101 lx	RZ 102 lx	RZ 103 lx	RZ 107 lx	RZ 201 lx	RZ 202 lx	RZ 203 lx	RZ 212 lx
Code	SBM 01022903	SBM 02022903	SBM 03022903	SBM 04022903	SBM 01032904	SBM 02032904	SBM 03032904	SBM 04032904
Height (mm)	1040		1040		1990		1990	
Width (mm)	600	800	100	1200	600	800	1000	1200
Depth (mm)	435		435		435		435	
Cabinet's capacity	2 rows of binders		2 rows of binders		5 rows of binders		5 rows of binders	
Number of shelves	2		2		4		4	

<b>Top cabinets</b>								
Designation	RZ 801 lx	RZ 802 lx	RZ 803 lx	RZ 804 lx	RZ 401 lx	RZ 402 lx	RZ 403 lx	RZ 405 lx
Code	SBM 01122902	SBM 02122902	SBM 03122902	SBM 04122902	SBM 01012902	SBM 02012902	SBM 03012902	SBM 04012902
Height (mm)	810		810		465		465	
Width (mm)	600	800	1000	1200	600	800	1000	1200
Depth (mm)	435		435		435		435	
Cabinet's capacity	2 rows of binders		2 rows of binders		2 low rows		2 low rows	
Number of shelves	1		1		1		1	

# OFFICE FURNITURE

## ADDITIONAL EQUIPMENT

## ADDITIONAL EQUIPMENT



shelf



extendable shelf



extendable drawer



extendable frame drawer for hanging files

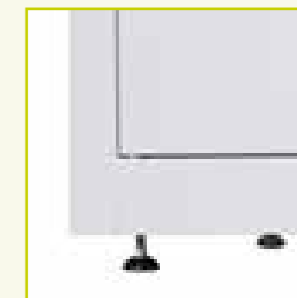

leveling feet



## TECHNICAL SPECIFICATION

For office cabinets we often need some additional equipment:

- **additional shelf** - adjustable every 25 mm ± 3 positions ( ± 4 positions in small cabinets - Sbm 101, 102, 103, 107),
- **extendable shelf, drawer and frame drawer** - Adjustable every 25 mm ± 2 positions from the centre, mounted on full extension ball bearing slides.

Standard shelves' maximum load capacity:

- cabinets with wing doors - 60 kg, 80 kg (optional),
- cabinet with retractable doors and shutter doors - 40 kg.

There are also additional tops for office cabinets (choice of tops on page 102).

Shelf	Shelf 60 kg		Shelf 60 kg		Shelf 80 kg			
	Code	Code	Code	Code	Code	Code	Code	Code
Designation	Shelf 60 kg		Shelf 60 kg		Shelf 80 kg			
Code	XSBM 18600101	XSBM 18640101	XSBM 18680101	XSBM 18720101	XSBM 22600901	XSBM 22640901	XSBM 22680901	XSBM 22720901
Height (mm)	28		28		23			
Width (mm)	594	794	994	1194	594	794	994	1194
Depth (mm)	385		385					
Applicable to	SBM 101 M	SBM 102 M	SBM 103 M	SBM 107 M	SBM 101 M	SBM 102 M	SBM 103 M	SBM 107 M

Shelf for cabinets with retractable and shutter doors	Shelf		Shelf
	Code	Code	Code
Designation	Shelf		Shelf
Code	XSBMZ 11200601	XSBMZ 11210601	XSBMZ 11190601
Height (mm)	23		23
Width (mm)	847	1047	647
Depth (mm)	385		385
Applicable to	SBM 105 M /208 M/210 M	SBM 109 M	SBM 701





# OFFICE FURNITURE

## ADDITIONAL EQUIPMENT

For office cabinets we often need some additional equipment:

- **additional shelf** - adjustable every 25 mm ± 3 positions, ± 4 positions in small cabinets - Sbm 101, 102, 103, 107,
- **extendable shelf, framer drawer, full drawer**, - Adjustable every 25 mm ± 2 positions, mounted on full extension ball bearing slides.

The proposed elements allow to adjust each cabinet to match individual customers' needs.

Extendable shelf							
	for cabinets with winged doors		for cabinets with winged doors		for cabinets with retractable/shutter doors		
	Code	XSBM 19761701    XSBM 19801701	XSBM 19841701    XSBM 19881701	XSBMZ 12320701    XSBMZ 12330701			
	Height (mm)	52		52			
	Width (mm)	424    624	824    1024	771    971			
	Depth (mm)	370		370		357	
	Applicable to	SBM 101 M    SBM 102 M	SBM 103 M    SBM 107 M	SBM 105 M/208 M/ 210 M    SBM 109 M			



Frame drawer							
	for cabinets with winged doors		for cabinets with winged doors		for cabinets with retractable/shutter doors		
	Code	XSBM 21920301    XSBM 21960301	XSBM 21A10301    XSBM 21A50301	XSBMZ 14560301    XSBMZ 14570301			
	Height (mm)	95		95			
	Width (mm)	424    624	824    1024	751    951			
	Depth (mm)	358		358		360	
	Applicable to	SBM 101 M    SBM 102 M	SBM 103 M    SBM 107 M	SBM 105 M/208 M/210 M    SBM 109 M			

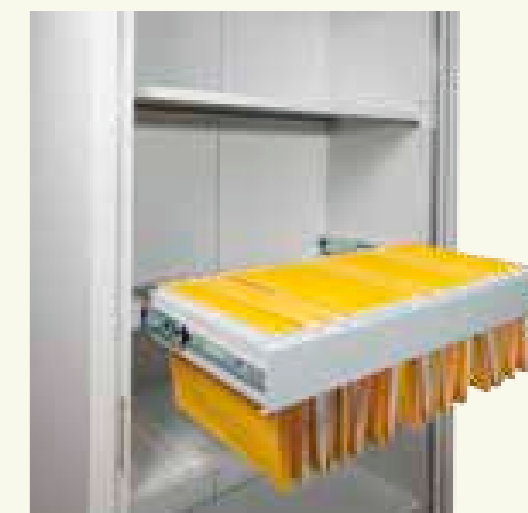

Shelf							
	for cabinets with winged doors		for cabinets with winged doors		for cabinets with retractable/shutter doors		
	Code	XSBM 20761801    XSBM 20801801	XSBM 20841801    XSBM 20881801	XSBMZ 13440801    XSBMZ 13450801			
	Height (mm)	102		102			
	Width (mm)	424    624	824    1024	771    971			
	Depth (mm)	370		370		370	
	Applicable to	SBM 101 M    SBM 102 M	SBM 103 M    SBM 107 M	SBM 105 M/ 208 M/ 210 M    SBM 109 M			

# OFFICE FURNITURE

## SKB CABINETS FOR DOCUMENTS AND FILES

Cabinets for documents and files are a perfect and practical combination of a cabinet for files with a cabinet for other documents.

Drawers are installed on double extension ball bearing slides, protected from falling out.

Cabinets have a special mechanism allowing for opening of only one of the drawers at a time which protects the cabinet against tipping.

Drawers are equipped with a central locking mechanism.

Maximum load capacity of each drawer is approx. 40 kg.

The cabinet is made of powder coated steel sheet and the bottom part of the cabinet is made of zinc galvanized steel sheet.

Door handle is equipped with lock securing cabinet in 2 points.

In the part for documents, the shelves are adjustable every 25 mm.

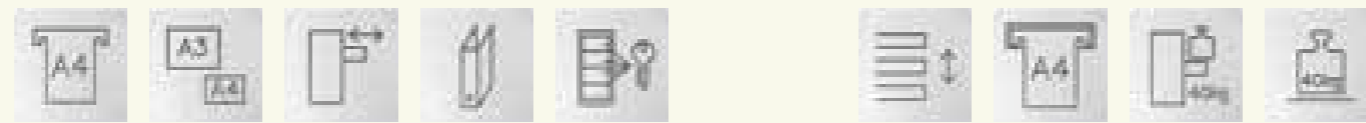

### TECHNICAL SPECIFICATION

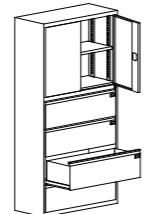
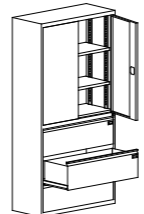
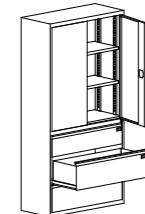
			
Designation	Skb 1	Skb 2	Skb 3
Code	SKB 01010201	SKB 01010202	SKB 01010203
Height (mm)	1990	1990	
Width (mm)	1000	1000	100
Depth (mm)	435	435	
Capacity of drawers	4 drawers for hanging files, A4 size, hanging horizontally	3 drawers for hanging files, A4 size, hanging horizontally	2 drawers for hanging files, A4 size, hanging horizontally
Number of shelves	1 shelf – for two rows of binders	2 shelves – for two rows of binders + 1 low shelf	2 shelves – for 3 rows of binders

# OFFICE FURNITURE

## SAM W REINFORCED CABINETS FOR DOCUMENTS

## SZK 301 OG FILING CABINETS WITH INCREASED FIRE RESISTANCE

## SAM W REINFORCED CABINETS FOR DOCUMENTS

This cabinet is filled with fireproof mineral wool – ideal for keeping important documents. The cabinet has filling protecting against fire. Doors are bolted – secured with certified lock in 'A' class.

For Sam W cabinets we offer - as an option:

- a compartment,
- an extendable shelf,
- a frame drawer.

It is also possible to anchor the cabinet to the floor, or to install a combination lock.

## FILING CABINETS WITH INCREASED FIRE RESISTANCE

Double sheet steel cabinet. The space between cabinet sheets is filled with a fireproof material. Fire resistant filling significantly extends the time of fire access to the documents. Fireproof seal protects the cabinet's content from quick warming. It is possible to store A4, Folio, Grand Folio documents.



### TECHNICAL SPECIFICATION

Designation	Szk 301og
Code	SZKW 01030301
Height (mm)	1380
Width (mm)	530
Depth (mm)	635
Number of shelves	4
Number of rows per drawer	1
Internal dimensions of drawers (mm)	H x W x D: 240 (front 318 mm) x 385 x 540
Maximal size of files (mm)	265 x 383

Designation	Sam W 1a	Sam W 2a	Sam W 3a
Code	SAMW 01010102	SAMW 02020203	SAMW 03020203
Height (mm)	1500	1950	1950
Width (mm)	700	950	1260
Depth (mm)	550		550
Cabinet's capacity	4 rows of binders	5 rows of binders	5 rows of binders
Number of shelves	3	4	4

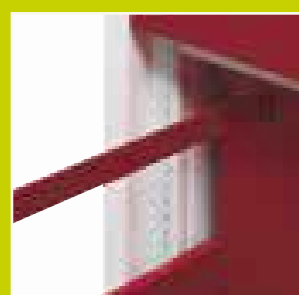
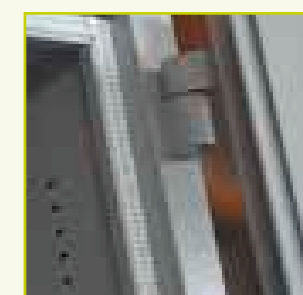

# OFFICE FURNITURE

## SZK FILING CABINETS

Filing cabinets are made of steel sheet with a base made of zinc galvanized steel sheet. Drawers are installed on double extension ball bearing slides, protected against falling out. Cabinets have a special mechanism that allow for opening of only one of the drawers at a time which protects the cabinet against tipping. Drawers are equipped with a central locking mechanism. Maximum load capacity of each drawer is approx. 50 kg. There are self-adhesive cardholders available in relation to the number of drawers. Cabinets are equipped with the shims for leveling. Cabinets available in various price versions.



### TECHNICAL SPECIFICATION



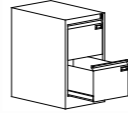
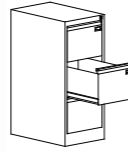
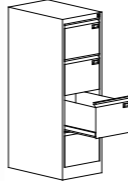
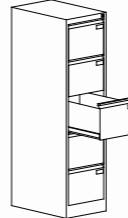
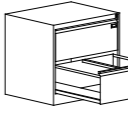
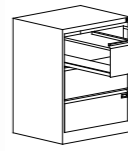
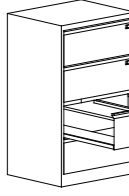

							
Designation	Szk 101	Szk 201	Szk 301	Szk 301/5	Szk 102	Szk 202	Szk 302
Code	SZK 01010101	SZK 01020201	SZK 01030301	SZK 01140401	SZK 02010801	SZK 02020901	SZK 02031001
Height (mm)	715	1000	1285	1568	715	1000	1285
Width (mm)	415		415		775		
Depth (mm)	630		630		630		
Number of shelves	2	3	4	5	2	3	4
Number of rows per drawer	1		1		2		
Internal dimensions of drawers (mm)	H x W x D: 244 (front 280 mm) x 330 x 585		H x W x D: 244 (front 280 mm) x 330 x 585		H x W x D: 244 (front 280 mm) x 690 x 585		
Size	A4		A4		A4		



# OFFICE FURNITURE

## FILING CABINETS

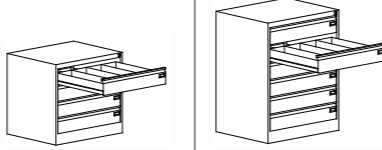
Additional equipment – available at an extra charge:  
 - supports for drawers,  
 - top plate (selection of plates on page 102).

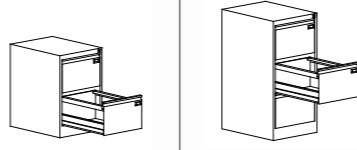
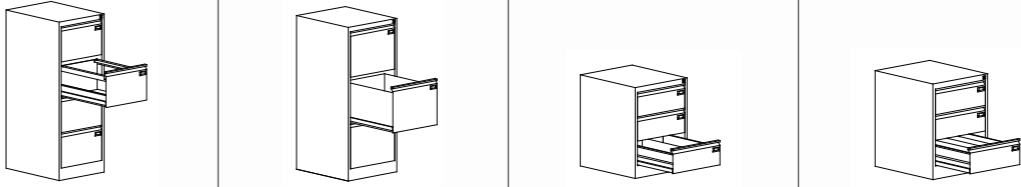
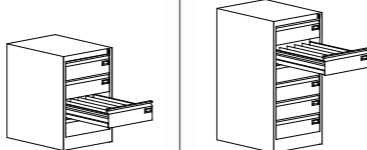
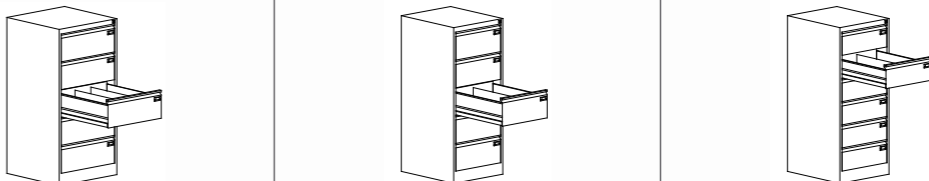
			
Designation	Szk 103      Szk 203		Szk 303      Szk 322      Szk 324
Code	SZK 02011401      SZK 02021501		SZK 02031602      SZK 06032702      SZK 07033302
Height (mm)	715      1000		1285
Width (mm)	775		775      520      470
Depth (mm)	630		630
Number of shelves	4      6		8      6      8
Number of rows per drawer	4		4      5
Internal dimensions of drawers (mm)	H x W x D: 100 (front 137) x 690 x 585		H x W x D: 100 (front 137) x 690 x 585      H x W x D: 105 (front 223) x 432 x 585      H x W x D: 95 (front 137) x 382 x 585
Size	A6		A6      180 x 105 mm      130 x 72 mm
			
Designation	Szk 104      Szk 204		Szk 306      Szk 3A3      Szk 114      Szk 115
Code	SZK 04010501      SZK 04020601		SZK 04030701      SZK 05031701      SZK 06012302      SZK 06012602
Height (mm)	715      1000		1240      715
Width (mm)	481		481      535      520
Depth (mm)	630		630
Number of shelves	2      3		4      3      3      3
Number of rows per drawer	1		1      2      4
Internal dimensions of drawers (mm)	H x W x D: 244 (front 280) x 398 x 585		H x W x D: 244 (front 280) x 398 x 585      H x W x D: 330 (front 365) x 450 x 585      H x W x D: 105 (front 185) x 432 x 585      H x W x D: 105 (front 185) x 432 x 585
Size	Din A4, Folio, Grand Folio		Din A4, Folio, Grand Folio      A3      180 x 213 mm      180 x 105 mm
			
Designation	Szk 117      Szk 215		Szk 319      Szk 320      Szk 321
Code	SZK 07013102      SZK 07023202		SZK 09032202      SZK 06032502      SZK 06032402
Height (mm)	715      1000		1285
Width (mm)	470		610      520
Depth (mm)	630		630
Number of shelves	4      6		5      6
Number of rows per drawer	5		3      2
Internal dimensions of drawers (mm)	H x W x D: 95 (front 137) x 382 x 585		H x W x D: 150 (front 223) x 522 x 585      H x W x D: 150 (front 223) x 432 x 585      H x W x D: 105 (front 223) x 432 x 585
Size	103 x 72 mm		215 x 170 mm      215 x 213 mm      180 x 213 mm

# OFFICE FURNITURE

## FILING CABINETS

We provide very popular filing cabinets for A5 (horizontal and vertical) and B5 (horizontal) files. A great variety of possible heights allow for adjusting a cabinet to every interior and every need of users.

Additional equipment – available at an extra charge.  
 - drawers support,  
 - top plates (selection of the top plates on page 102).



### TECHNICAL SPECIFICATION

Designation	Szk 305		Szk 304/2	Szk 304/3	Szk 304/4	Szk 304
Code	SZK 02031301		SZK 03063401	SZK 03073501	SZK 03083601	SZK 03031101
Height (mm)	1285		605	830	1060	1285
Width (mm)	775		545			
Depth (mm)	630		630			
Number of shelves	5		2	3	4	5
Number of rows per drawer	4		2			
Internal dimensions of drawers (mm)	H x W x D: 100 (front 223) x 690 x 585		H x W x D: 187 (front 223) x 460 x 585			
Size	A5 vertically		A5 horizontally			

Designation	Szk 318/1/5	Szk 318/2		Szk 318/3	Szk 318/4	Szk 318	Szk 318/6	Szk 318/7
Code	SZK 11035002	SZK 09064502		SZK 09074602	SZK 09084702	SZK 09032102	SZK 09134802	SZK 09154902
Height (mm)	1285	605		830	1060	1285	1510	1740
Width (mm)	345	610		610				
Depth (mm)	630			630				
Number of shelves	5	2		3	4	5	6	7
Number of rows per drawer	1	2		2				
Internal dimensions of drawers (mm)	H x W x D: 150 (front 223) x 262 x 585	H x W x D: 150 (front 223) x 522 x 585		H x W x D: 150 (front 223) x 522 x 585				
Size	B5 vertically			B5 horizontally				

# OFFICE FURNITURE

## SCD CABINETS FOR CDS

CD's can be kept in three rows – 22 discs in each row. CD's supporters inside the drawer are movable. Each drawer can be labelled with self-adhesive card holders placed on the front of each drawer. Drawer's full extension allow for an easy access to all CD's. Drawers are equipped with a central locking mechanism. Drawers are installed on double extension telescopic ball bearing slides, protected against falling out. Top plate as standard. Selection of top plates on page 102.



### TECHNICAL SPECIFICATION

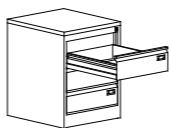
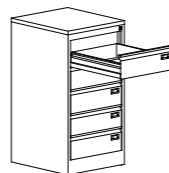
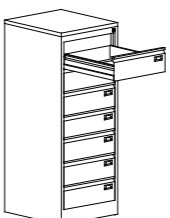

			
Designation	Scd 33	Scd 35	Scd 37
Code	SZK 08041802	SZK 08051902	SZK 08032002
Height (mm)	630	956	1285
Width (mm)	505	505	505
Depth (mm)	565	565	565
Number of shelves	3	5	7
Number of rows per drawer	3	3	3
Internal dimensions of drawers (mm)	height x depth 155 x 505	height x depth 155 x 505	
Number of stored discs	3 rows x 22 x 3 drawers = 198 discs	3 rows x 22 x 5 drawers = 330 discs	3 rows x 22 x 7 drawers = 462 discs

# OFFICE FURNITURE

## SRM DRAWING CABINETS

Cabinets for drawings, maps, printing plates and technical documentation that ensure safe, practical and organized storage of these materials. Cabinets are designed for A0/ A1 sizes.

For individual requirements of our customers we are able to divide drawers, with additional partitions, into various sizes – from A4 to A1.

Maximum load capacity of each drawer is approximately 50 kg.

Drawers are installed on full extension ball bearing slides protected against falling out.



Center cylinder lock secures all drawers.

The cabinets can be placed directly on the floor or on the socles.



### TECHNICAL SPECIFICATION

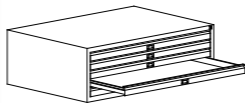
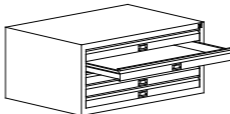
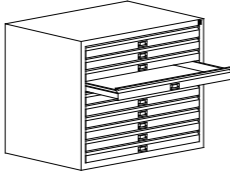

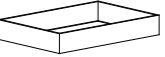
					
Designation	Srm 100	Srm 101	Srm 201	Srm 100 socle	Srm 101, Srm 201 socle
Code	SRM 02010102	SRM 01010102	SRM 01020102	CSRSM 0201	CSRSM 0101
Height (mm)	425	425	770	140	
Width (mm)	1315	970		1290	945
Depth (mm)	920	670		895	645
Internal dimensions of drawers (mm)	height x width x depth 45 x 1235 x 895	height x width x depth 45 x 890 x 630		-	
Number of drawers	5	5	10	-	
Size	A0	A1		A0	A1

# OFFICE FURNITURE

## CLASSROOM FURNISHING E-CLASS

### CLASSROOM FURNISHING

Cabinets designed for keeping and sorting documents, mails etc. They are perfectly suitable for places such as reading rooms or staffrooms, e.g. to store registers.

The cabinets are equipped with adjustable shelves. The Sbmk 1 cabinet is additionally equipped with an extendable desk and a locked compartment.

### E-CLASS

We offer complex furnishing of modern multimedia classrooms. Our offer includes: laptop and tablet lockers and trolleys. Modern desks, lockers with compartments for books and school supplies, filing cabinets.

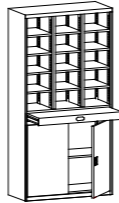
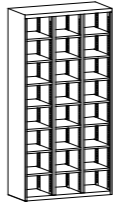

## TECHNICAL SPECIFICATION

		
Designation	Sbmk1	Sbmk2
Code	SBMK 01010202	SBMK 01010101
Height (mm)	1990	1990
Width (mm)	1000	1000
Depth (mm)	435	435
Number of shelves	12	21





# OFFICE FURNITURE

## SKT CABINETS FOR CATALOGUES

Cabinets for catalogues cards allow to organize and systematize collections in each library. Body of the cabinet is made of sheet steel, painted powder paint.

Cabinet equipped with extended drawers on ball bearing slides, with see-through front made of plexi glass, adapted to catalogue cards of size 110 x 170 mm (Skt 1) or cards of size 125 x 75 mm (Skt 2). Drawers are protected against removing the cards.

Cabinets are placed on a base, made of 40 x 40 mm closed profile with adjustable height.

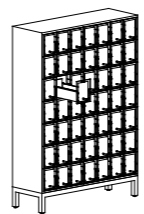
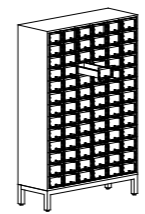

### TECHNICAL SPECIFICATION

		
	Skt 1	Skt 2
Designation	Skt 1	Skt 2
Code	SKT 01010101	SKT 02020102
Height (mm)	1645	1635
Width (mm)	1150	1080
Depth (mm)	390	390
Internal dimensions of drawers (mm)	H x W x D: 95 (front 190) x 120 x 350	H x W x D: 65 (front 90) x 135 x 350
Number of shelves	49	78
Maximal size of files	110 x 170	125 x 75





# OFFICE FURNITURE

## LIBRARY RACKS

Library racks – ideal for reading rooms. Racks are equipped with vertical separators and supports for books, newspapers and other documents, with information label on each module. Rack's frame is made of steel closed profile. Adjustable feet. Shelves adjustable every 50 mm. Racks are produced in two versions – as single side and double side racks.

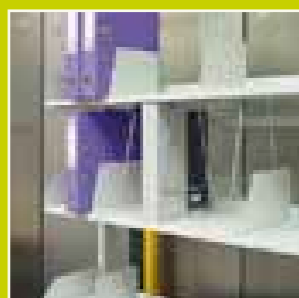

### TECHNICAL SPECIFICATION

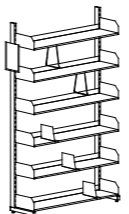
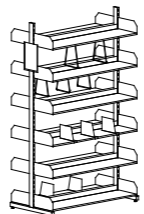
		
Designation	Rmb 1	Rmb 2
Code	RMB 0101010101	RMB 0101010201
Height (mm)	2060	2060
Width (mm)	1030	1030
Depth (mm)	310	560
Number of shelves	6	12 (6 on each side)
Equipment	compartments – 12, book supports – 6	compartments – 24, book supports - 12



# OFFICE FURNITURE

## STB OFFICE DESKS

Thanks to its minimalistic form and timeless design STB COMFORT desks match all interiors.

Desks are based on solid 50 x 50 mm square profile legs. Table legs are equipped with adjustable feet allowing for height leveling.

The cable duct under the top allow to store cables, power supply or power strip in an aesthetic way.

Table tops are made of top-quality 18 mm thick melamine covered board or 16 mm thick MDF board.

Black veneer of tops' edges stress the unique character of STB comfort office desks.

Tables are delivered in parts for an easy assembly.



### TECHNICAL SPECIFICATION

Designation	Stb 1060		Stb 1260	Stb 1460	Stb 1660	Stb 1860
Code	MST 0101010101		MST 0201010101	MST 0301010101	MST 0401010101	MST 0501010101
Height (mm)	745+770		745+770			
Width (mm)	1000		1200	1400	1600	1800
Depth (mm)	600		600			

Designation	Stb 1080		Stb 1280	Stb 1480	Stb 1680	Stb 1880
Code	MST 0601010101		MST 0701010101	MST 0801010101	MST 0901010101	MST 1001010101
Height (mm)	745+770		745+770			
Width (mm)	1000		1200	1400	1600	1800
Depth (mm)	800		800			

# OFFICE FURNITURE

## DESKS CONNECTORS

Available options of desks equipment:

- perforated front cover,
- desks connectors,
- accessories: cable connector, cable duct.

Desk connectors configuration:

- half-round connector,
- quarter round connector.

To improve comfort of a user it is possible to order front covers. These covers allow to hide from view things that are under the desk and additionally, they separate legs of interlocutors. Front covers are made of the powder coated metal sheet.



Holes in the cover are cut with laser, what aesthetically distinguishes them from other metal covers.

Thanks to desk connectors it is possible to adjust desk arrangement depending on space and shape of a room.

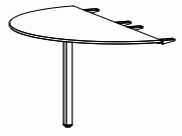
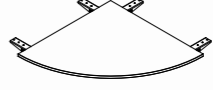

### TECHNICAL SPECIFICATION

					
Designation	half-round connector 60		half-round connector 80	quarter round connector 60	quarter round connector 80
Code	XMST 02060202		XMST 02070202	XMST 03080202	XMST 03090202
Height (mm)	745+770		745+770		
Width (mm)	1200		1600	600	800
Depth (mm)	600		800	600	800

						
Designation	front cover 10		front cover 12	front cover 14	front cover 16	front cover 18
Code	XMST 01010101		XMST 01020101	XMST 01030101	XMST 01040101	XMST 01050101
Height (mm)	330		330			
Width (mm)	846		1046	1246	1446	1646

# OFFICE FURNITURE

## SZP MOBILE PEDESTALS

Mobile pedestals of proved quality allow for practical furnish of office space. Thanks to the application of the highest quality steel, SZP mobile pedestals are extremely long-lasting and stable. Full extension ball bearings slides provide smooth and simple extension of drawers. SZP mobile pedestals are equipped with central locking system opening and closing all the drawers at the same time.

Available mobile pedestals:  
 - lower (520 mm high), able to be used as a seat,  
 - higher (663 mm high) allow to use the space under the desk to the maximum.

The top of SZP mobile pedestals is made of 18 mm thick melamine covered board or 16 mm MDF board. Possibility to choose either metal or melamine fronts make it possible to adjust them to each interior.

We offer two types of containers: with 2 and 3 drawers. Pedestals equipped with 4 swivel wheels, including 2 wheels with brakes. They can be covered with melamine top or optionally MDF. Drawers are installed on full extension ball bearing slides - 45 kg load capacity.



Drawers' size: 330 x 420 mm.

Pedestals are locked with a central lock placed on the right side of a pedestal.

Mobile pedestal's accessories:  
 - plastic pencil box as an insert,  
 - drawers' fronts made of melamine covered board.

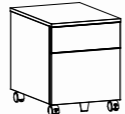

### TECHNICAL SPECIFICATION

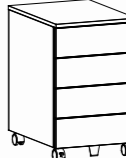
				
Designation	Szp 520	Szp 530	Szp 630	Szp 640
Code	MSZP 0101010101	MSZP 0101020101	MSZP 0102030101	MSZP 0102040101
Height (mm)	517	517	662	
Width (mm)	417	417		
Depth (mm)	556	556		
Equipment	1 high drawer 1 low drawer	3 low drawers	1 high drawer 2 low drawers	4 low drawers

# OFFICE FURNITURE

## TABLE TOPS

Table tops have a wide range of application in offices or open-space objects. They are characterized by a modern design and ergonomics. Legs of the table are equipped with leveling feet. The construction enables to hide cables in cable ducts. Tops are made of 18 mm thick melamine or optionally 16 mm thick MDF board.

### COLOURS OF TOPS:

- Grey,
- Cream,
- White,
- Black,
- Beech (at an extra cost).

Sides covered with black veneer.

### CABLE DUCT:

A horizontal structural beam under the top strengthens the stiffness of the construction and serves as a horizontal channel allowing for an aesthetic hiding of wires. This ensures that all your cables are in their place and workplace looks exceptionally aesthetic.

#### STANDARDOWE



Grey



Cream



White



Black

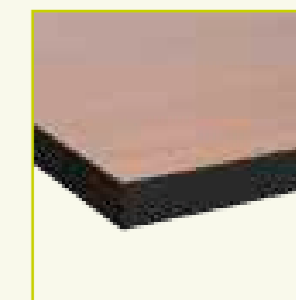

Beech

#### AT AN EXTRA COST





# OFFICE FURNITURE

## TOWER PEDESTALS

Tower pedestals designed to store the most necessary documents and items. This allows to keep the workplace clean.

Low tower pedestal is an extension of a workplace. Low tower pedestal has one row for binders, extendable shelf and lockable compartment in the upper part for personal items.

The front panel has a handle and a lock with two keys.

High tower pedestal separates workplaces providing discretion, noise reduction and better working conditions. High tower pedestal has 3 rows for binders, extendable shelf and lockable compartment in the upper part for personal items. The front panel has a handle and a lock with two keys.

All tower pedestals are made of steel with a choice of fronts and tops made entirely of metal or board ( colour range like for tops in STB Comfort series).

On special order we can produce tower pedestal with perforations and/ or sound insulation.

## MOBILE PEDESTALS WITH UPHOLSTERED SEAT

Mobile pedestals with upholstered seat allow to store important items and to be used as a seat at the same time. They are perfect for modern offices where comfort is as important as free exchange of information. A person approaching the desk doesn't have to stand, during the conversation, and the person sitting behind the desk do not feel uncomfortable in such situation when one person is sitting while the other one is standing. As a standard, the seat is mounted to the container with magnets, what facilitates cleaning the seat.

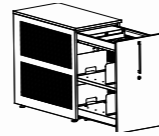

### TECHNICAL SPECIFICATION

Low tower pedestal		
	Description	CB 748      CB 748
Code	CB 0206061700	CB 0206061706
Heigh (mm)	750	750
Width (mm)	438	438
Depth (mm)	800	800
Equipment	- metal top and front - 1 shelf - 2 small compartments in the top	- melamine top and front - 1 póika - 2 small compartments in the top

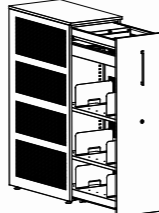
High tower pedestal		
	Description	CB 1348      CB 1348
Code	CB 0207061805	CB 0207061806
Heigh (mm)	1320	1320
Width (mm)	438	438
Depth (mm)	800	800
Equipment	- metal top and front - 2 shelves - 2 small compartments in the top	- melamine top and front - 2 shelves - 2 small compartments in the top

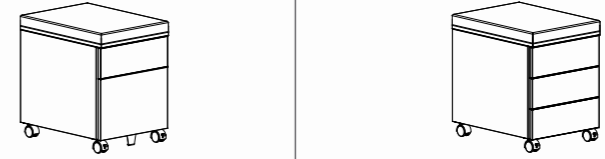
Mobile pedestal				
	Description	Szp 522s      Szp 520s      Szp 532s      Szp 530s		
Code	MSZ 0103010401	MSZ 0103010402	MSZ 0103020401	MSZ 0103020402
Heigh (mm)	550	550	550	550
Width (mm)	420	420	420	420
Depth (mm)	556	556	556	556
Equipment	- seat with magnets - metal front - 1 high drawer - 1 low drawer	- seat with magnets - metal front - 1 high drawer - 1 low drawer	- seat with magnets - metal front - 3 low drawers	- seat with magnets - melamine front - 3 low drawers

## MEDIAPORTS

Mediaports with possibility of connecting the most important media directly to sockets placed in a table. Lockable cover with brush pass allows for ergonomic use of mediaport, both in the open and closed position. We give to you the possibility of any configuration of necessary slots.



### POWER SOCKETS:

Mediaport can be equipped in slots: round with pin, max. loading 16A/230V; round SCHUKO, max. 16A/230V

### COMPUTER SLOTS

Mediaport can be equipped in moduls with slots: RJ45 cat.5e or cat.6 screen, RJ12 telephone slot, USB-A or USB-B, Chinch, HDMI, Mini Jack, VGA, BNC, Sat (F), TV, S-Video, Optic, backlit power switch. Mediaport can be equipped with 2 to 10 media modules.



# SOCIAL FURNITURE

*Furniture  
you can depend on*



# SOCIAL FURNITURE

## CONTENTS

SUM W Wardrobe lockers	110
SUL W Wardrobe lockers	118
SUS W Lockers with compartments	124
SUS W Lockers with compartments - 300 mm module	126
SUS W Lockers with compartments - 400 mm module	130
Slanted tops and socles for WSU wardrobe lockers	134
Benches for WSU wardrobe lockers	136
School lockers	140
Laptop trolleys	146
Tablet trolleys	148
School desks	150
Laptop and mobile phones lockers	152
Social lockers with MDF doors	154
Canteen lockers	158
KBS Lockers for cleaning purposes	160
SMD Lockers for cleaning staff	162
MPO Metal recycling bin	164
Lockers for fire fighters	166
Army wardrobe	168
Wardrobes with heating and ventilation for clothes drying	170
Sports furniture	172
Tables, benches, chairs and stands	176
School chairs	178
School desks, blackboards	180
Bespoke furniture – examples	182

Metal social furniture guarantees functionality and an aesthetic value of social spaces in factories, schools, sports halls, fitness clubs, swimming pools etc. Proper arrangement of those rooms, taking into consideration a wide range of requirements and needs, guarantees a sense of well-being and increases the standards of workplace.

The main advantage of SUM W, SUS W, SUL W lockers produced on the new line is advanced construction based on closed profiles, which are implemented in sides of doors, in the middle of the body and in the bottom of a locker. Lockers are certified, approved and they meet EU safety standards. Doors perforation registered as an industrial design.



Wardrobes on legs



Wardrobes with slanted top



Height-adjustable feet



The possibility of hanging clothes



On wheels



Made of galvanized steel sheet



Made of acid proof stainless steel sheet



Made of stainless steel sheet



Various types of locks



Master system



With electrical components - safe



Ventilation and ventilation with heating



Standard equipment



Standard equipment



Door opening angle 180°



110° Door swing angle



Possibility of fixing



Possibility of mounting to a wall

# SOCIAL FURNITURE

## SUM W WARDROBE LOCKERS



a bar with hooks

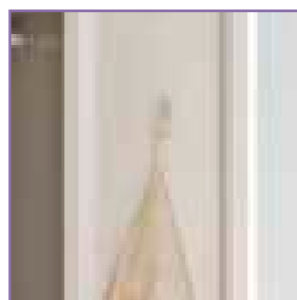

a hook for towel



a mirror

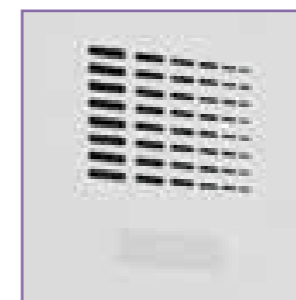

a self adhesive nameplate



a shelf



an internal partition (in 400 mm wide modules)

Wardrobe lockers allow to furnish social rooms in a functional and aesthetic way. Wide range of products guarantees fulfilling even the most varied users' needs. A modern design perforation system allows free air circulation. Welded construction based on closed profiles affects the rigidity of the lockers.

**SUM W WARDROBE LOCKERS ARE MADE IN TWO WIDTHS:**

- 300 mm,
- 400 mm (with internal partition wall to separate clean and dirty clothes).

**STANDARD EQUIPMENT:**

- a bar with hooks,
- a hook for towel,
- a mirror,
- a self adhesive nameplate,
- a shelf above the bar,
- an internal partition (in 400 mm wide modules).



### MEDALIST WARDROBES



# SOCIAL FURNITURE

## SUM W WARDROBE LOCKERS

Thanks to additional equipment our social lockers meet customer's requirements and expectations in 100%.

Slanted tops help maintain cleanness, socles and benches provide the functionality and ergonomics.

Seats of the benches consist of three wooden slats coated with clear varnish or three plastic slats.

All benches increase the height of the cabinet by 390 mm.



### ADDITIONAL EQUIPMENT



slanted top

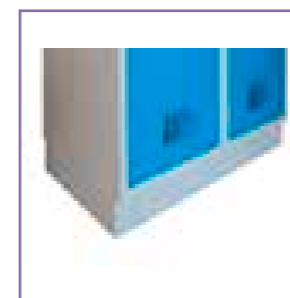

socle screwed to the lockers (140 mm high)



leg frame (140 mm high)

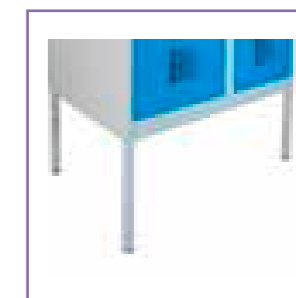

base without seat equipped with adjustable feet



base with seat equipped with adjustable feet



base with seat equipped with adjustable feet – economical version



extendable bench equipped with adjustable feet



base without seat equipped with adjustable feet – economical version

### TYPES OF LOCKS

In social wardrobes it is possible to have a keylock (C) or a handle which is adapted to hang a padlock (D) on it.

It is possible to order lockers with MASTER key which allows opening certain number of locks.

Locks available at an extra cost:

- cylindrical moisture-resistant lock,
- coin locks (E) – return coin lock (F) or non-return coin locks (G),
- mechanical (H) and electronic code locks (I) and others – on customer's request.

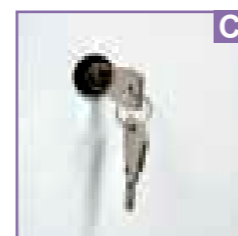

3-point cylinder lock (A)

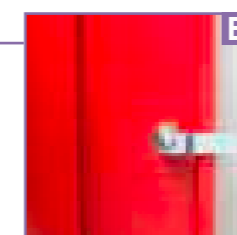
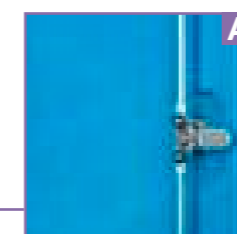

1-point cylinder lock (B)

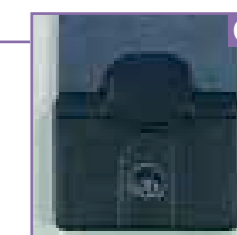
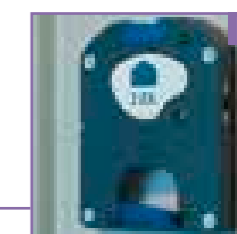
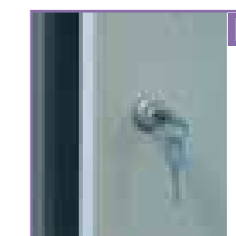
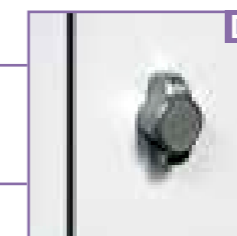

# SOCIAL FURNITURE

## SUM W WARDROBE LOCKERS

### ADVANTAGES OF SUM W WARDROBES:

- wide range of equipment as a standard,
- 16 colours at no extra cost,
- various types of locks to choose,
- socles, bases, legs, slanted tops etc.,
- increased usable space,
- seals of approval, certificates, declarations.



### ADVANTAGES OF SUM W WARDROBES



### MEDALIST WARDROBES



standard wide range of equipment



16 colours at no extra cost



various types of locks to choose

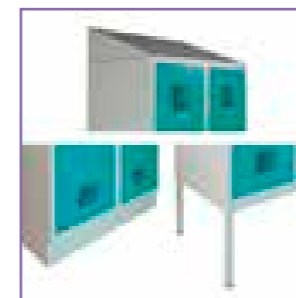

socles, bases, legs, slanted tops etc.



different price versions

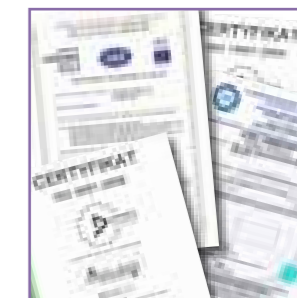

seals of approval, certificates, declarations

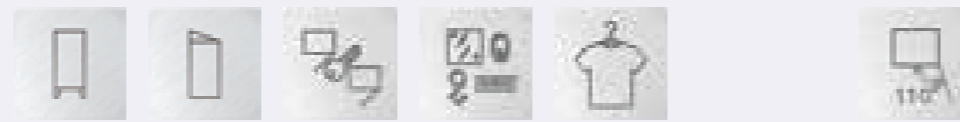

# SOCIAL FURNITURE

## SUM W WARDROBE LOCKERS

SUM W Wardrobe lockers												
	Designation	Sum 310 W	Sum 311 W	Sum 320 W	Sum 321 W	Sum 330 W	Sum 331 W	Sum 340 W	Sum 341 W			
Code	WSU 0101020102	WSU 0101020202	WSU 0102020102	WSU 0102020202	WSU 0103020102	WSU 0103020202	WSU 0104020102	WSU 0104020202				
Height (mm)	1800	1940	1800	1940	1800	1940	1800	1940				
Width (mm)		300	600		900		1200					
Depth (mm)		500	500									
Number of units		1	2		3		4					
Number of doors		1	2		3		4					
Legs	-	+	-	+	-	+	-	+				

SUM W Wardrobe lockers										
	Designation	Sum 410 W	Sum 411 W	Sum 420 W	Sum 421 W	Sum 430 W	Sum 431 W			
Code	WSU 0201020103	WSU 0201020103	WSU 0202020103	WSU 0202020203	WSU 0203020103	WSU 0203020203				
Height (mm)	1800	1940	1800	1940	1800	1940				
Width (mm)		400	800		1200					
Depth (mm)		500	500							
Number of units		1	2		3					
Number of doors		1	2		3					
Legs	-	+	-	+	-	+				





# SOCIAL FURNITURE

## SUL W WARDROBE LOCKERS

### SUL W WARDROBE LOCKERS

In order to make use of small spaces such as cloak-rooms, an ideal solution is our L-shape wardrobe locker.

Thanks to SUL W wardrobe lockers, one can place twice as many wardrobe compartments as with wardrobe lockers.

Welded construction based on closed profiles affects the rigidity of the wardrobes.



### ADVANTAGES OF SUL W WARDROBES



### MEDALIST WARDROBES



standard wide range of equipment



16 colours at no extra cost



various types of locks to choose

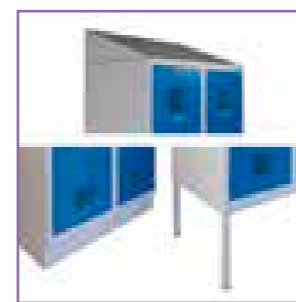

socles, bases, legs, slanted tops etc.



different price versions



seals of approval, certificates, declarations

# SOCIAL FURNITURE

## SUL W WARDROBE LOCKERS

### SUL W WARDROBE LOCKERS

SUL W wardrobe lockers are produced in two types of module width:  
- 300 mm,  
- 400 mm.

A modern design perforation system allows free air circulation.

Available locks: 1-point lock.



### STANDARD EQUIPMENT



### MEDALIST WARDROBES



1-point lock



a bar with hook



a self-adhesive nameplate



# SOCIAL FURNITURE

## SUL W WARDROBE LOCKERS

SUM W Wardrobe lockers												
	Designation	SUL 31 W	SUL 31 W	SUL 32 W	SUL 32 W	SUL 33 W	SUL 33 W	SUL 34 W	SUL 34 W			
Code	WSU 0306030104	WSU 0306030204	WSU 0306030204	WSU 0307030204	WSU 0308030104	WSU 0308030204	WSU 0309030104	WSU 0309030204				
Height (mm)	1800	1940	1800	1940	1800	1940	1800	1940				
Width (mm)	300		600		900		1200					
Depth (mm)	500		500		500		500					
Number of units	2		4		6		8					
Number of doors	2		4		6		8					
Legs	-	+	-	+	-	+	-	+				

SUM W Wardrobe lockers										
	Designation	SUL 41 W	SUL 41 W	SUL 42 W	SUL 42 W	SUL 43 W	SUL 43 W			
Code	WSU 0406030104	WSU 0406030204	WSU 0407030104	WSU 0407030204	WSU 0408030104	WSU 0408030204				
Height (mm)	1800	1940	1800	1940	1800	1940				
Width (mm)	400		800		1200					
Depth (mm)	500		500		500					
Number of units	2		4		6					
Number of doors	2		4		6					
Legs	-	+	-	+	-	+				



# SOCIAL FURNITURE

## SUS W WARDROBE LOCKERS

Lockers with compartments, thanks to their functionality, variety and aesthetic qualities can be used in a wide range of facilities, e.g. in cloakrooms, kindergartens, schools, boarding schools, swimming pools, fitness clubs, gyms, railway stations, workplaces - for storing briefcases, handbags, helmets etc.

Welded construction based on closed profiles affects the rigidity of the wardrobes.



### ADVANTAGES OF SUS W WARDROBES



### MEDALIST WARDROBES



standard wide range of equipment



16 colours at no extra cost



various types of locks to choose



socles, bases, legs, slanted tops etc.



different price versions

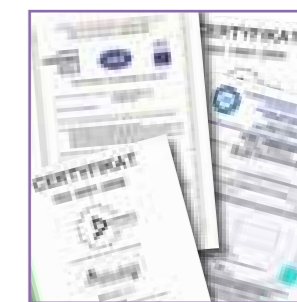

seals of approval, certificates, declarations

# SOCIAL FURNITURE

## SUS W WARDROBE LOCKERS - 300 mm wide module

Depending on customers' needs we offer different types of SUS W lockers with compartments:  
 - 300 and 400 mm wide modules,  
 - various number of compartments: from 2 up to 20.

A modern design perforation system allows free air circulation.



### STANDARD EQUIPMENT







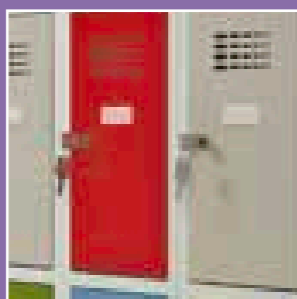

### TECHNICAL SPECIFICATION



bar with hooks (in lockers with two compartments per module)



self adhesive nameplate

300 mm wide modules								
Designation	SUS 312 W	SUS 312 W n	SUS 322 W	SUS 322 W n	SUS 332 W	SUS 332 W n	SUS 342 W	SUS 342 W n
Code	WSU 0106020104	WSU 0106020204	WSU 0107020104	WSU 0107020204	WSU 0108020104	WSU 0108020204	WSU 0109020104	WSU 0109020204
Height (mm)	1800	1940	1800	1940	1800	1940	1800	1940
Width (mm)	300		600		900		1200	
Depth (mm)	500		500		500		500	
Number of units	1		2		3		4	
Number of doors	2		4		6		8	
Legs	-	+	-	+	-	+	-	+





# SOCIAL FURNITURE

## SUS W WARDROBE LOCKERS - 300 mm wide module

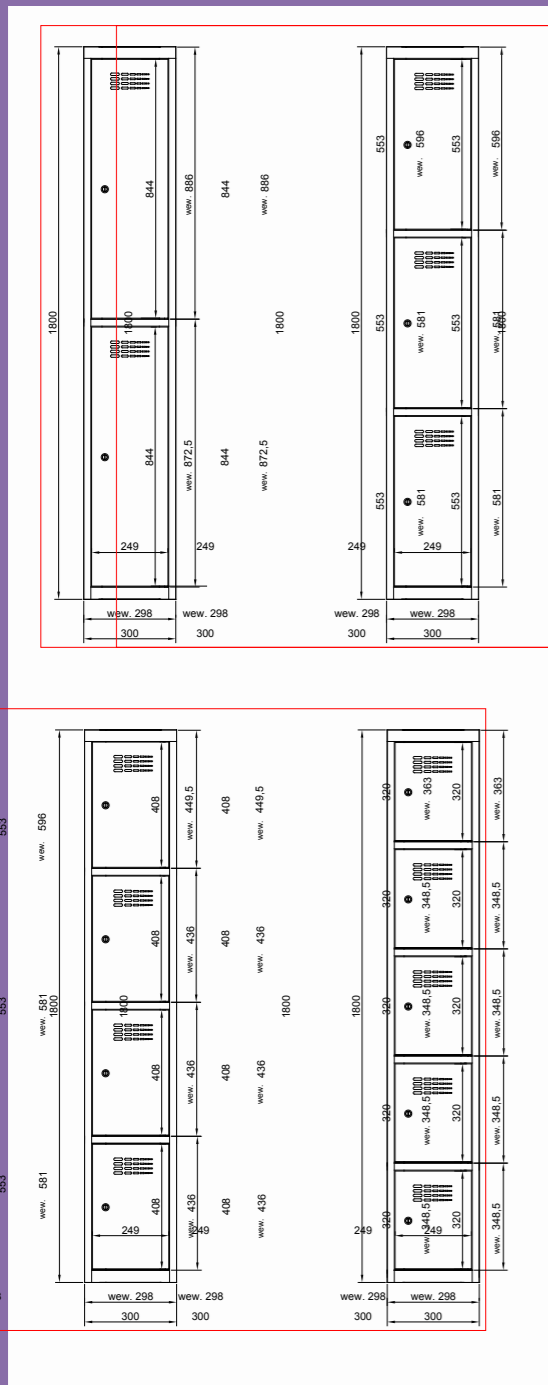

	300 mm wide modules		300 mm wide modules		300 mm wide modules		300 mm wide modules		300 mm wide modules			
Designation	SUS 313 W	SUS 313 W n	SUS 314 W	SUS 314 W n	SUS 315 W	SUS 315 W n	SUS 323 W	SUS 323 W n	SUS 333 W	SUS 333 W n	SUS 343 W	SUS 343 W n
Code	WSU 0111020101	WSU 0111020201	WSU 0116020101	WSU 0116020201	WSU 0121020101	WSU 0121020201	WSU 0112020101	WSU 0112020201	WSU 0113020101	WSU 0113020201	WSU 0114020101	WSU 0114020201
Height (mm)	1800	1940	1800	1940	1800	1940	1800	1940	1800	1940	1800	1940
Width (mm)	300		300		300		600		900		1200	
Depth (mm)	500		500		500		500		500		500	
Number of units	1		1		1		2		3		4	
Number of doors	3		4		5		6		9		12	
Legs	-		+		-		-		-		-	
							+		+		+	



# SOCIAL FURNITURE





SUS W WARDROBE LOCKERS - 400 mm wide module



## TECHNICAL SPECIFICATION

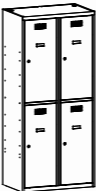
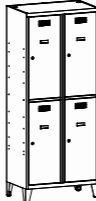

### MEDALIST WARDROBES









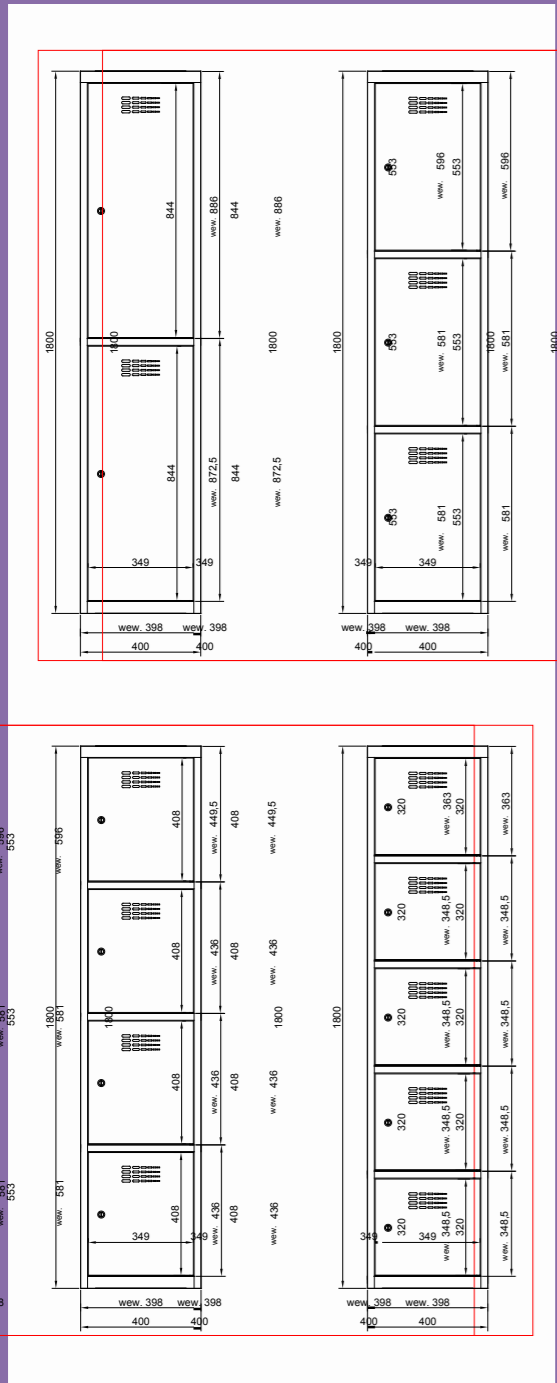

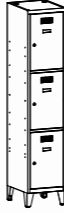



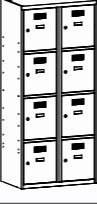

400 mm wide modules						
Designation	SUS 412 W	SUS 412 W n	SUS 422 W	SUS 422 W n	SUS 432 W	SUS 432 W n
Code	WSU 0206020104	WSU 0206020204	WSU 0207020104	WSU 0207020204	WSU 0208020104	WSU 0208020204
Height (mm)	1800	1940	1800	1940	1800	1940
Width (mm)	400		800		1200	
Depth (mm)	500		500			
Number of units	1		2		3	
Number of doors	2		4		6	
Legs	-	+	-	+	-	+



# SOCIAL FURNITURE

## SUS W WARDROBE LOCKERS - 400 mm wide module



400 mm wide modules						
Designation	SUS 413 W	SUS 413 W	SUS 423 W	SUS 423 W	SUS 433 W	SUS 433 W
Code	WSU 0211020101	WSU 0211020201	WSU 0212020101	WSU 0212020201	WSU 0213020101	WSU 0213020201
Height (mm)	1800	1940	1800	1940	1800	1940
Width (mm)	400		800		1200	
Depth (mm)	500					
Number of units	1		2		3	
Number of doors	3		6		9	
Legs	-	+	-	+	-	+
400 mm wide modules						
Designation	SUS 414 W	SUS 414 W	SUS 424 W	SUS 424 W	SUS 434 W	SUS 434 W
Code	WSU 0216020101	WSU 0216020201	WSU 0217020101	WSU 0217020201	WSU 0218020101	WSU 0218020201
Height (mm)	1800	1940	1800	1940	1800	1940
Width (mm)	400		800		1200	
Depth (mm)	500					
Number of units	1		2		3	
Number of doors	4		8		12	
Legs	-	+	-	+	-	+
400 mm wide modules						
Designation	SUS 415 W	SUS 415 W	SUS 425 W	SUS 425 W	SUS 435 W	SUS 435 W
Code	WSU 0221020101	WSU 0221020201	WSU 0222020101	WSU 0222020201	WSU 0223020101	WSU 0223020201
Height (mm)	1800	1940	1800	1940	1800	1940
Width (mm)	400		800		1200	
Depth (mm)	500					
Number of units	1		2		3	
Number of doors	5		10		15	
Legs	-	+	-	+	-	+



# SOCIAL FURNITURE

## SLANTED TOPS AND SOCLES FOR WSU WARDROBE LOCKERS

Wardrobe lockers can be equipped with slanted tops that help to maintain cleanness in social spaces.

- Slanted tops help to maintain the cleanness on top of the locker by making it easy to sweep and to dust.
- Simple assembly - with latches.



### TECHNICAL SPECIFICATION

Slanted tops							
	Designation	D310 W	D320 W	D330 W	D410 W	D420 W	D430 W
	Code	DWSU 010101	DWSU 010102	DWSU 010103	DWSU 020101	DWSU 020102	DWSU 020103
	Height (mm)	200		200			
	Width (mm)	300	600	900	400	800	1200
	Depth (mm)	500		500			

Socles								
	Designation	C310 W	C320 W	C330 W	C340 W	C410 W	C420 W	C430 W
	Code	CWSU 010101	CWSU 010102	CWSU 010103	CWSU 010104	CWSU 020101	CWSU 020102	CWSU 020103
	Height (mm)	140		140				
	Width (mm)	300	600	900	1200	400	800	1200
	Depth (mm)	450		450				



# SOCIAL FURNITURE

## BENCHES FOR WSU WARDROBE LOCKERS

Cabinets can be placed on benches, and then fixed with screws.

The seat consists of three wooden slats coated with clear varnish or plastic slats, especially recommended for use in wet environments.

We offer 2 price versions:

- standard (frames and legs are made of closed profiles),
- economic (frame is made of bent steel sheet, legs of closed profiles).

In our offer, we have very practical, extendable benches which help to save space. These benches are ideal where it is essential to organize a space effectively. The bench has an extendable seat, which fits under the wardrobe.

Bench with legs														
	WCn 311 W		WCn 321 W		WCn 331 W		WCn 341 W		WCn 411 W		WCn 421 W		WCn 431 W	
	PWSU 09020101		PWSU 09020201		PWSU 09020301		PWSU 09020401		PWSU 10020101		PWSU 10020201		PWSU 10020301	
	Height (mm) 140													
	Width (mm) 275		Width (mm) 575		Width (mm) 875		Width (mm) 1175		Width (mm) 375		Width (mm) 775		Width (mm) 1175	
Depth (mm) 450														

One-side benches														
	P311 W		P321 W		P321 W		P 331 W		P411 W		P 421 W		P 431 W	
	PWSU 01010102		PWSU 01010103		PWSU 01010202		PWSU 01010302		PWSU 01010303		PWSU 02010202		PWSU 02010303	
	Height (mm) 390													
	Width (mm) 290		Width (mm) 590		Width (mm) 590		Width (mm) 890		Width (mm) 390		Width (mm) 790		Width (mm) 1190	
Depth (mm) 745														
Wooden slats		+		+		+		+		+		+		
Plastic slats		+		+		+		+		+		+		

One-side benches – economic version														
	P313 W		P323 W		P323 W		P 333 W		P413 W		P 423 W		P 433 W	
	PWSU 05010102		PWSU 05010103		PWSU 05010203		PWSU 05010302		PWSU 05010303		PWSU 06010202		PWSU 06010303	
	Height (mm) 390													
	Width (mm) 290		Width (mm) 590		Width (mm) 590		Width (mm) 890		Width (mm) 390		Width (mm) 790		Width (mm) 1190	
Depth (mm) 745														
Wooden slats		+		+		+		+		+		+		
Plastic slats		+		+		+		+		+		+		



# SOCIAL FURNITURE

## BENCHES FOR WSU WARDROBE LOCKERS

Benches without a seat							
	Designation	P311 W	P321 W	P331 W	P411 W	P421 W	P431 W
	Code	PWSU 01010101	PWSU 01010201	PWSU 01010301	PWSU 02010101	PWSU 02010201	PWSU 02010301
	Height (mm)	390	390				
	Width (mm)	290	590	890	390	790	1190
Depth (mm)	490	490					

Benches without a seat – economical version							
	Designation	P313 W	P323 W	P333 W	P413 W	P423 W	P433 W
	Code	PWSU 05010101	PWSU 05010201	PWSU 05010301	PWSU 06010101	PWSU 06010201	PWSU 06010301
	Height (mm)	390	390				
	Width (mm)	290	590	890	390	790	1190
Depth (mm)	490	490					

Extendable benches												
	Designation	Pw311 W	Pw321 W	Pw321 W	Pw331 W	Pw411 W	Pw421 W	Pw431 W				
	Code	PWSU 07010102	PWSU 07010103	PWSU 07010202	PWSU 07010302	PWSU 07010303	PWSU 08010102	PWSU 08010103	PWSU 08010202	PWSU 08010203	PWSU 08010302	PWSU 08010303
	Height (mm)	390			390							
	Width (mm)	290	590	590	890	390	790	1190				
	Depth (mm)	745			745							
	Wooden slats	+		+	+		+		+		+	
Plastic slats		+		+		+		+		+		

# SOCIAL FURNITURE

## SCHOOL LOCKERS

School lockers are made of top quality steel. The bottom of the locker is made of galvanized steel to additionally protect it from corrosion. We use powder coatings from leading global manufacturers. Wide range of standard colours – 16 RAL colours.

As a standard we offer 1- or 3-points locking cylinder locks (in selected products). It is also possible to order other locks, according to individual needs. Most of our school lockers can be produced with legs or be placed on benches. Our lockers have declarations and certificates of compliance with Polish and European norms, as well as hygienic certificate issued by PZH (National Institute of Public Health).

1450 mm high school locker is designed for younger pupils. In doors of the lockers there are ventilation holes allowing for free exchange of air.

Lockers with compartments are made in different price versions – depending on thickness and type of steel sheet of which they are made (including galvanized or acid-proof steel).

We also offer lockers with compartments with additional equipment as follows:

- a bar with hooks,
- a book shelf for notebooks, handheld things, etc.



### ADVANTAGES OF SCHOOL LOCKERS

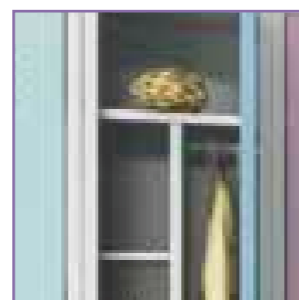

standard wide range of equipment



16 colours at no extra cost



various types of locks to choose



socles, bases, legs, slanted tops etc.



different price versions

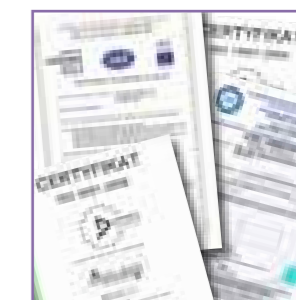

seals of approval, certificates, declarations



# SOCIAL FURNITURE

## SCHOOL LOCKERS

### SUM S LOCKERS FOR PRE-SCHOOLERS

In our offer we also have 1350 mm high Sum S lockers for kindergarteners. Even the youngest children will be able to hang their clothes and reach the shelves without any effort.

Cloakrooms in kindergarten equipped with wardrobe lockers enhance kids' independence. Children who have their own individual lockers more willingly and actively prepare to their classes.

The standard locker is equipped with 1-point cylinder lock.

Other options of the lock:

- 3-point lock,
- a handle with magnetic closure.

### SUM S LOCKERS FOR 6-YEAR-OLDS

Sum S locker is 1500 mm high, so younger children have more space compared to Sus lockers with compartments, and they can hang their clothes and reach shelves easily. Locker is equipped with a bar with hooks, a hook on doors and shelves for books, notebooks and handheld things.



### TECHNICAL SPECIFICATION

SUM S CABINETS for preschoolers		
	SumS 310	SumS 320
Designation	SumS 310	SumS 320
Code	SUM 1702020510	SUM 1802020510
Height (mm)	1500	
Width (mm)	300	600
Depth (mm)	500	
Number of units	1	2
Number of doors		

SUM S Locker for 6-year-olds		
	SumS 330	SumS 340
Designation	SumS 330	SumS 340
Code	SUM 1902020510	SUM 2002020510
Height (mm)	1500	
Width (mm)	900	1200
Depth (mm)	500	
Number of units	3	4
Number of doors		

SUM S Locker for 6-year-olds				
	SumS 310p	SumS 320p	SumS 330p	SumS 340p
Designation	SumS 310p	SumS 320p	SumS 330p	SumS 340p
Code	SUM 1703040112	SUM 1803040112	SUM 1903040112	SUM 2003040112
Height (mm)	1350		1350	
Width (mm)	300	600	900	1200
Depth (mm)	500			
Number of units	1	2	3	4
Number of doors				

# SOCIAL FURNITURE

## SCHOOL LOCKERS

We offer also different types of the lockers with original perforations of the doors, with various heights: 1560 mm, 1650 mm. These lockers are a part of additional offer for the customers who appreciate uniqueness, reliability and high quality.

It is just a sample of our possibilities. We are able to produce almost every your request!

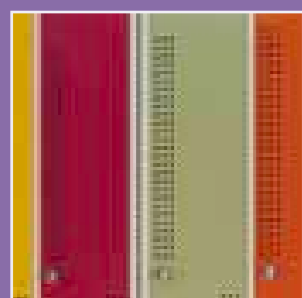
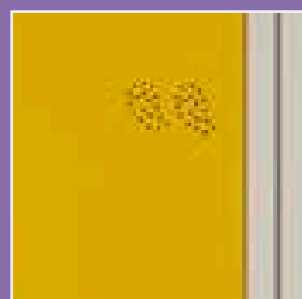

### TECHNICAL SPECIFICATION

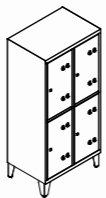
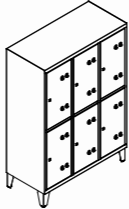
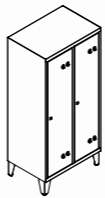
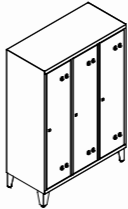
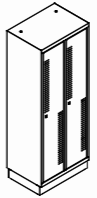
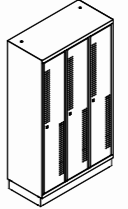
WFD School lockers	 		   				
	Designation	WFD DFD 422350	WFD DFD 432350	WFD DFD 421350	WFD DFD 431350	WFD GS 2	WFD GS 3
Code	SFDB 2407220210	SFDB 2408220210	SFDB 2402220209	SFDB 2403220209	SFDB 2202200306	SFDB 2203200306	
Height (mm)	1560		1560		1650		
Width (mm)	725	1075	725	1075	625	925	
Depth (mm)	500		500		450		
Equipment	reinforced doors with opening limiter, a shelf		reinforced doors with opening limiter, top and bottom shelf, a bar, perforated bottom		reinforced doors with opening limiter, top and bottom shelf, a bar		



# SOCIAL FURNITURE

## LAPTOP/TABLET TROLLEYS

Trolley for laptops with function of battery charging is used to storage and easy transport of laptops. It is ideal for schools, colleges, libraries, conference halls, or anywhere where there is a need for secure storage and simultaneous laptops charging. WNL trolley is particularly useful in a classroom, where students need to charge laptops and store them safely. Thanks to the WNL trolley one can easily and safely move laptops from one class to another.

WNL trolley is used to store, secure and charge simultaneously from 10 to 30 laptops.



For the overload protection the sequencer is used, which enables to turn on the particular power strips after the specified time (~3 minutes) which results in a low maintenance of electrical load of the trolley during the charging process. A light-emitting diode is signalling the work of power strips of the laptop trolley.

Doors of the trolley are protected against unauthorized access by a key lock with locking in two points.

WNL Laptop Trolley was awarded the European Medal.

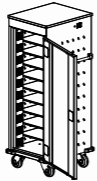

### MEDALIST TROLLEYS

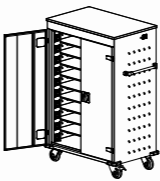
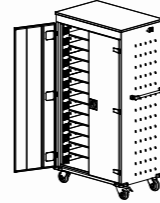
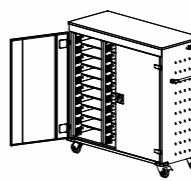
Laptop/tablet trolleys					
Designation	WNL 110	WNL 208	WNL 210	WNL 213	WNL 310
Code	WNL 0514060204	WNL 0615050404	WNL 0614050404	WNL 0616050404	WNL 0714050404
Height (mm)	1250	1060	1250	1540	1250
Width (mm)	530	920	920		1310
Depth (mm)	500		500		
Number of compartments	10	16	20	26	30

The trolley's top is covered with melamine. The frame has holes, for air circulation. Maximum laptop size: 90 x 340 x 470 mm (17 inch).

The trolley frame is made of polyster-epoxy painted metal.

Trolley has a Certificate of Compliance with European Directive 2001/95 concerning product safety.

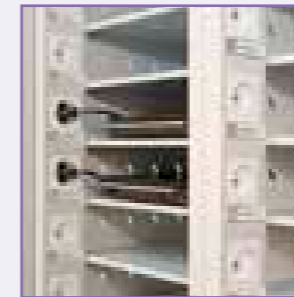

#### Work safety

A sequencer and 2 fuses to protect against overloaded lines. Trolley has a Certificate of Compliance with European Directive 2001/95 concerning product safety.

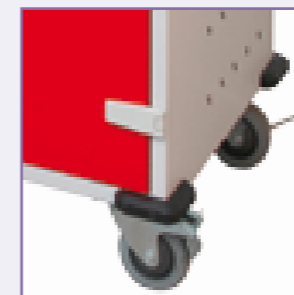

#### Mobility

Easy to move thanks to 100 mm diameter swivel wheels covered with non-marking rubber (2 of them with brakes).

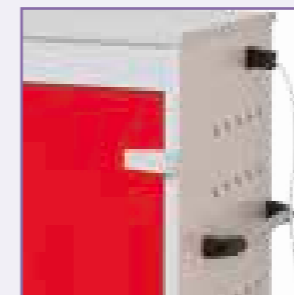

#### Ergonomics

Handles mounted on both sides and a top make the trolley easy to use.

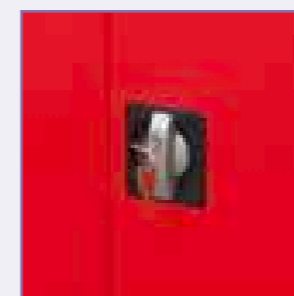

#### Security

Doors of the trolley are secured with a key lock blocking it in 2 points. Trolley's side edges are secured with rubber corners.



# SCHOOL FURNITURE E-CLASS

## TABLET TROLLEYS

Tablet trolley with function of battery charging is used to store and transport 32 tablets + 1 laptop. It is ideal for schools, colleges, libraries, conference rooms – anywhere where there is a need for secure storage and simultaneous tablets charging.

The trolley is equipped with:

- socket to charge the laptop,
- two cables: with IEC C5 and IEC C7 output,
- inserts made out of incombustible foam allowing to store 32 tablets (maximal size 12x205x295 mm, ~12,2"),
- numbered compartments,
- a shelf (100x340x520 mm) with a socket for laptop,
- handles on both sides,
- four 100 mm diameter swivel wheels (made out of non-marking rubber) of 150 kg load capacity per wheel, two of them with breaks,
- bottom sides covered with melamine,
- doors with 2-point lock,
- melamine top (18 mm thick, with cut corners, with black scaleboards),
- ventilation holes for air circulation in the body,
- three-metre-long supply cable,
- handle on the side for reel of supply cable.

### WNT Trolley's advantages:

- possibility of simultaneous charge of up to 32 devices (tablet, smartphone and additionally one laptop),
- each USB port equipped with LED diode confirming correctness of work,
- double circuit-breaker protection and protection against overload,
- protection against overheating,
- implementation of single loading time limiter (up to 5 hours) to safe the batteries of currently charging devices and to decrease energy consumption..

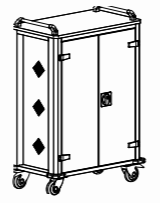

## TECHNICAL SPECIFICATION

	
Designation	WNT 33
Code	WNL0917050604
Height (mm)	1050
Width (mm)	730
Depth (mm)	440
Number of compartments	32 tablets + 1 laptop



# SCHOOL FURNITURE E-CLASS

## SCHOOL DESKS

### Q8 SCHOOL DESK

Very functional school desk with stable and rigid construction, equipped with feet adjustable ~15 mm.

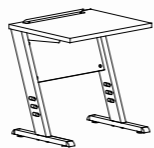
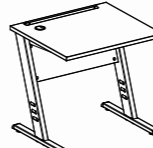

## TECHNICAL SPECIFICATION

Q8 School desk		
Designation	Q8	Q8B
Code	XXXP 010029C	XXXP 010029D
Height (mm)	720	760
Width (mm)	700	800
Depth (mm)	580	700

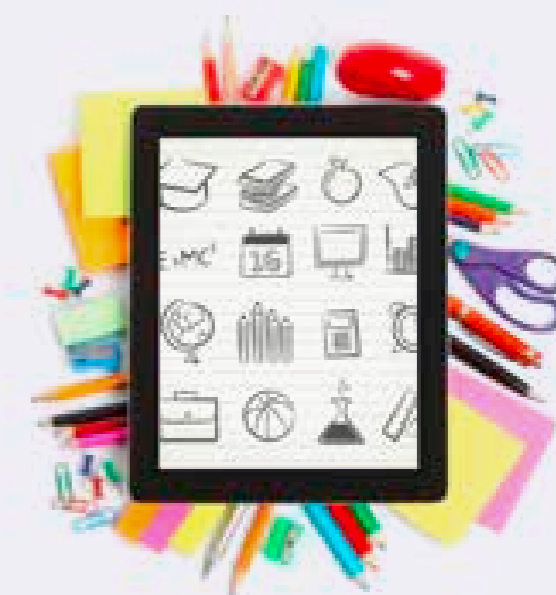



# SOCIAL FURNITURE

## LOCKERS FOR LAPTOPS / MOBILE PHONES

### LAPTOP LOCKERS

Laptop lockers are designed to secure laptops and to charge their batteries during storage. Inside the body there is a power strip mounted. Laptop's locker without electric installation is also available.

### AND MOBILE PHONES LOCKERS

Lockers to store mobile phones are used in the pass control offices, agencies, institutions, libraries, reading rooms and other places where mobile phones are forbidden. These lockers can also be used as key deposits.



### TECHNICAL SPECIFICATION

Laptop locker		
Designation	Locker for laptops SZNL 4110	
Code	SZNL 0101010101	SZNL 0101010104
Height (mm)	1800	
Width (mm)	400	
Depth (mm)	500	
Number of compartments	10	
Description	Locker without wiring	Locker with wiring



WSS locker for mobile phones										
	Designation	WSS 5	WSS 10	WSS 20	WSS 30	WSS 35	WSS 50	WSS 55	WSS 60	WSS 80
Code	WSS 06010601	WSS 01010101	WSS 02010201	WSS 03020301	WSS 07010701	WSS 03030801	WSS 03040901	WSS 04030401	WSS 05030501	WSS 08031001
Height (mm)	780			930	780	1530	1680	1530		
Width (mm)	210	390	750	930	1290	930		1110	1470	1650
Depth (mm)	200			200						
Number of compartments	5	10	20	30	35	50	55	60	80	90



# SOCIAL FURNITURE

## SOCIAL FURNITURE WITH MDF DOORS

Lockers with MDF doors are perfect combination of excellent technical parameters of a metal cabinet with aesthetics and ecology of a MDF board.

MDF is an ideal substitute of wood with no structural imperfections such as knots or cracks which are typical for wood. Unified both composition and density makes it an ideal material. The use of colourful or wood-based fronts with MDF gives the wardrobe locker the effect of lightness, comfort and a unique appearance

The doors of high quality laminated MDF board.

Galvanized hinge strips were used.



AVAILABLE COLOURS OF MDF DOORS



K 2081 SPARTA



F 7024 SAFFRON

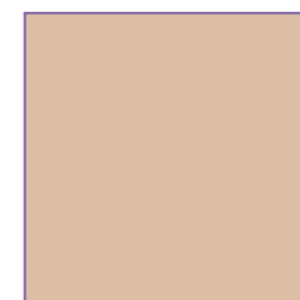

F 7858 PUMICE



F 2828 TROPICAL BLUE



F 7845 SPECTRUM RED



K 7024 BIRCH

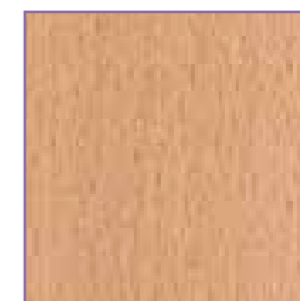

K 7016 FINN BEECH



# SOCIAL FURNITURE

## SOCIAL LOCKERS WITH MDF DOORS

The locker has ventilation holes which provide proper air circulation. The bottom of the locker or base is protected against corrosion.

Bodies of the lockers are made of 0.8 - 1.0 mm thick high quality steel.

Covered with high-quality powder coat.

The standard cylindrical lock with blocking in point.

SUS wardrobe locker with MDF doors						
	Designation	SUS 312	SUS 314	SUS 315	SUS 322	SUS 324
Code	NSUM 0106070104	NSUM 0116070101	NSUM 0121070101	NSUM 0107070104	NSUM 0117070101	NSUM 0122070101
Height (mm)	1800		1800			
Width (mm)	300		300	600		
Depth (mm)	490		490			
Number of compartments	2	4	5	4	8	10

SUS wardrobe locker with MDF doors						
	Designation	SUS 412	SUS 414	SUS 415	SUS 422	SUS 424
Code	NSUM 0306070104	NSUM 0316070101	NSUM 0321070101	NSUM 0307070104	NSUM 0317070101	NSUM 0322070101
Height (mm)	1800		1800			
Width (mm)	400		400	800		
Depth (mm)	490		490			
Number of compartments	2	4	5	4	8	10

SUM wardrobe locker with MDF doors		
	Designation	SUL 41
Code	NSUM 0606070104	NSUM 0607070104
Height (mm)	1800	
Width (mm)	400	800
Depth (mm)	490	
Number of doors	2	4

SUM wardrobe locker with MDF doors				
	Designation	SUM 310	SUM 320	SUM 410
Code	NSUM 0101070102	NSUM 0102070102	NSUM 0301070103	NSUM 0302070103
Height (mm)	1800			
Width (mm)	300	600	400	800
Depth (mm)	490			
Number of units	1	2	1	2

# SOCIAL FURNITURE

## CANTEEN LOCKERS

Canteen lockers to store food products and personal items are perfect choice for such places as canteens or buffets.

Thanks to specially designed holes, it is possible to hang the lockers on the wall and to screw the lockers one to another to make bigger sets.

Each compartment is equipped with place for nameplate indicating the owner of the compartment. Each compartment with 2 keys. There is a possibility of ordering "Master" key that is able to open every compartment. Additionally the lockers are equipped with slanted top that helps maintain cleanness.

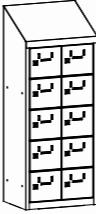
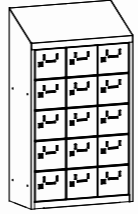
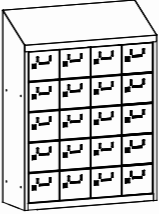
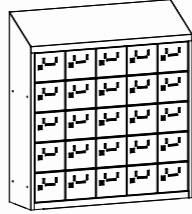

### TECHNICAL SPECIFICATION

Canteen lockers					
Designation	SUS 215W	SUS 225W	SUS 235W	SUS 245W	SUS 255W
Code	SUS 0821050601	SUS 0822050601	SUS 0823050601	SUS 0824050601	SUS 0825050601
Height (mm)	1090		1090		
Width (mm)	240	430	620	810	1000
Depth (mm)	300		300		
Number of compartments	5	10	15	20	25

# SOCIAL FURNITURE

## KBS LOCKERS FOR CLEANING PURPOSES

*For easy, safe and pleasant work...*

KBS locker is a very practical type of metal furniture both for the distribution of safety products and to store dirty clothes.

Each compartment is closed with an independent key, and common frame allows to open all the lockers at the same time.

The person distributing safety materials has an access to all the compartments, and thanks to this he or she can control the stock and regularly restock them.

The main advantage of KBS lockers is a significant reduction of industrial safety products, and thus reducing costs. Modules of the locker for dirty clothes allow throwing dirty clothes through the opening slot easily.

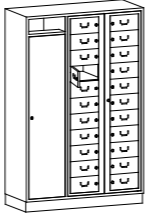
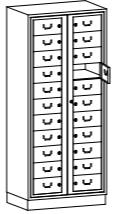
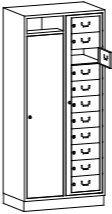
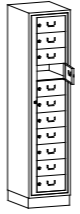

### TECHNICAL SPECIFICATION

KBS cabinet with compartments	 		 	
	Designation	KBS 1	KBS 2	KBS 3
Code	KBS 01050201	KBS 03050601	KBS 02050201	KBS 04050601
Height (mm)	1900		1900	
Width (mm)	1225	820	840	435
Depth (mm)	500		500	
Number of compartments	22 + compartment	22	11 + compartment	11

#### Facilitate the work

Provides easy access to safety products and / or storage of dirty clothes.

#### Savings

Reduces the cost of safety products.

#### Control

Control of safety products consumption.

#### Functionality

A possibility of giving back and collecting new products.

# SOCIAL FURNITURE

## SMD CABINETS FOR CLEANING STAFF

Multifunctional cabinets are used to store clothes, household cleaners, buckets, brushes, etc. They facilitate the work of social workers and the cleaning services.

### FUNCTIONALITY

- Depending on the needs SMD cabinet is equipped with:
- 4 non-adjustable shelves (SMD 60) or
  - Compartment with shelves and wardrobe section (SMD61) or
  - Compartment with shelves and compartment for a bucket and a brush (SMD 62).

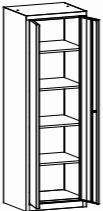
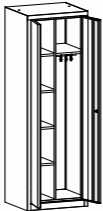
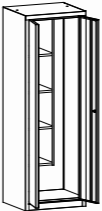

### TECHNICAL SPECIFICATION

SMD cabinet for cleaning staff			
	SMD 60	SMD 61	
Designation	SMD 60	SMD 61	SMD 62
Code	SAU 0401030201	SAU 0401030401	SAU 0401030501
Height (mm)	1800		1800
Width (mm)	600		600
Depth (mm)	500		500







# SOCIAL FURNITURE

## MPO METAL RECYCLING BIN

Containers designed for internal use for various wastes: plastic, paper, glass. The body made of 0,8-1,0 mm thick steel, covered with structure powder coating. Slanted top prevents wastes from piling on the top of the container.

Self-closing lids prevent odours from emitting and close the containers in an aesthetic way.

Containers allow gathering wastes in 120-litre disposal bags or in internal galvanized metal containers of following dimensions: 700x295x357 mm (option at an extra cost).

Access to containers is simple thanks to frontal winged doors locking with a free-turning latch lock with a possibility of padlock locking.

Extendable frame for disposal bags placed on full-extension ball bearing slides facilitates the access to disposal bags that are placed on a frame by pressing it down with upper part of the frame mounted on hinges.

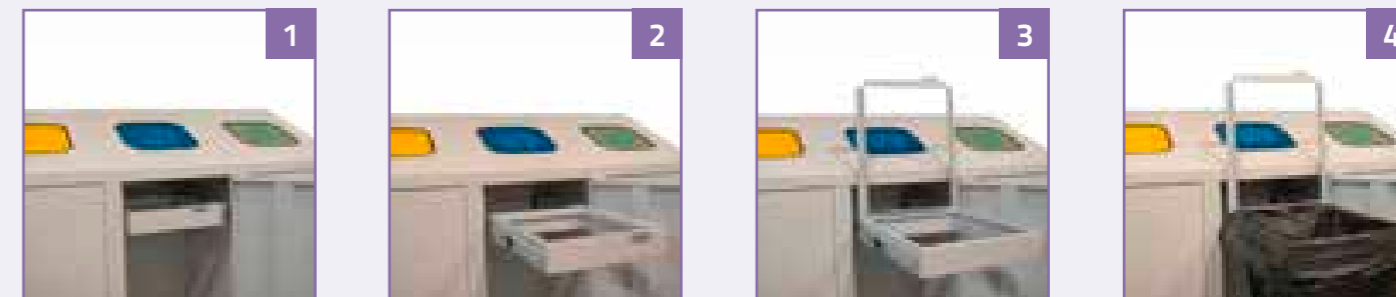

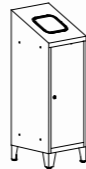
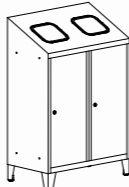
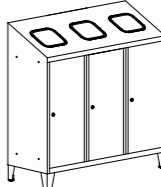
MPO metal recycling bin									
	Designation	MPO 01r	MPO 01k	MPO 02r	MPO 02k	MPO 02rk	MPO 03r	MPO 03k	MPO 03rrk
Code	PNO 0101010301	PNO 0101010201	PNO 0201010301	PNO 0201010201	PNO 0401020101	PNO 0301010301	PNO 0301010201	PNO 0301010601	PNO 0301010501
Height (mm)	1220		1220						
Width (mm)	400		800			1200			
Depth (mm)	450		450						
Number of units	1		2			3			
Equipment	1 extendable frame	1 bin	2 extendable frames	2 bins	1 extendable frame + 1 bin	3 extendable frames	3 bins	2 extendable frame + 1 bin	2 bins + 1 extendable frame

Galvanized bin		
	Designation	MPO k Galvanized container
Code	XPNO 01010101	
Height (mm)	700	
Width (mm)	295	
Depth (mm)	357	







# SOCIAL FURNITURE

## LOCKERS FOR FIRE FIGHTERS

Lockers for fire fighters are used to store clothes that fire fighters used during a fire fighting action.

The lockers are equipped with:

**Corrosion protection** - all locker made of galvanized steel.

For better air circulation it is possible to place the locker on the bench.

We produce lockers for firefighters and policemen for every European market. We would like to present the lockers produced for customers' special requests.

Lockers for firefighters		
Designation	SUS 41	SUS 42
Code	SST 07010201	SST 08010201
Height (mm)	1950	
Width (mm)	400	800
Depth (mm)	550	
Equipment	a bar for clothes hooks helmet holder	



shelf

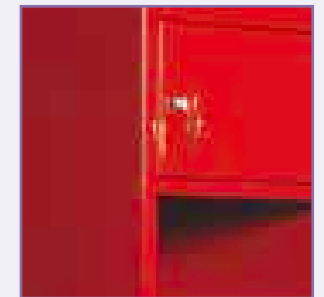

compartment closed with cylinder lock



storage handle for helmets



perforated bottom

## SPECIAL PRODUCTS



# SOCIAL FURNITURE

## ARMY WARDROBES

Military wardrobes designed according to requirements of Regional Infrastructure Administration/Military Infrastructure Administration. They are used to store quarter equipment.

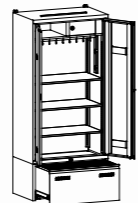
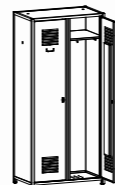
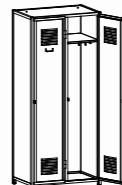

### TECHNICAL SPECIFICATION

Army wardrobes			
Designation	WP2-40	Sum 421 military 27719	Sum 421 military 27789
Code		SUM 0701030201D56	SUM 0701030201D61
Height (mm)	2225	1850	1850
Width (mm)	1000	850	850
Depth (mm)	600	490	520
Equipment	Winged doors with code lock with 10000 combinations, fixed shelf with box closed with code lock with 1000 combinations; 3 shelves movable on the height; metal chrome-plated bar with movable hooks with possibility of mounting on 3 heights. Extendable drawer with lid closed with code lock with 1000 combinations. The inside of the drawer divided with vertical partition: 1 movable shelf in right compartment; gas servomotors prevent the lid from self-closing.	- left + right doors, - metal bar, - 4 hooks for clothes (2 per compartment), - body made out of angle bar 25x25x3 mm and 1,0 mm thick steel.	- right doors, - metal bar, - 4 hooks for clothes (2 per compartment), - butt hinges - body made out of angle bar 25x25x3 mm, tee 30x30x4 mm and 1,0 mm thick steel.

# SOCIAL FURNITURE

## LOCKERS WITH HEATING AND VENTILATION FOR CLOTHES' DRYING

### LOCKERS WITH HEATING AND VENTILATION

Lockers with heating and ventilation were designed to dry wet clothes, shoes and gloves in closed rooms. This is a perfect solution wherever the environmental conditions cause dampness. These may be: construction sites, uniformed services, waterworks, railways, airports, mines, walk-in freezers, skiing resorts and many other.

The lockers are made out of powder coated steel sheet. They are equipped with connection terminals that enable connecting of ventilation duct.

There are several combinations of available lockers for clothes drying:

- locker with ventilation and socket enabling connection of 3 lockers in string,
- locker with heating and ventilation,
- locker with internal partitions in compartments, with heating and ventilation,
- locker with heating, ventilation, time switch and socket enabling connection of 3 lockers in string.

**Safety:**

- CE symbol,
- IP 21 resistance class,
- thermal protection against overheating.

## CABINET FOR CLOTHES AND SHOES' DRYING

Cabinet for drying clothes and shoes for 10 working sets of clothing. It is equipped with a bar to hang damp clothes and bottom compartment with 20 pipes for damp shoes. Long pipes enable hanging high working boots. Cabinet with adjustable feet and handles on the sides to move the cabinet easily. Plastic transparent curtain protects from excessive heat loss and enables an easy access to the dried clothes. Cabinet made out of fire galvanized steel sheet.



### TECHNICAL SPECIFICATION

Locker with heating and ventilation					
	Designation	SUM 421		SUM 421	SUM 421
Code	SUMW 0701030214	SUMW 0701030215	SUMW 0701030219	SUMW 0701030230	
Height (mm)	2006		2006		
Width (mm)	800		800		
Depth (mm)	490		490		
Equipment	- ventilation and heating 1000 W	- ventilation and heating 1000 W, - internal partitions in compartments	- ventilation and heating 1000 W, - internal partitions in compartments, - a time switch, - power socket to link 3 lockers	- ventilation, - power socket to link 3 lockers	

Cabinet for clothes and shoes' drying	
	Designation
Code	XXXXP 020055
Height (mm)	1971
Width (mm)	1515
Depth (mm)	500
Equipment	- a bar for clothes, - 20 pipes for shoes, - 2 heating and ventilation modules, - 2 handles to move the cabinet, - leveling feet

# SOCIAL FURNITURE

## SPORTS FURNITURE

### SPORT WARDROBE LOCKER

The door locked in 1 or 3 points. Door equipped with a opening limiter.

Locker's equipment:

- the right part – equipped with 3 fixed shelves,
- the left part - equipped with 1 lockable compartment and a bar.

At the bottom of the cabinet there is one compartment for shoes, together with extended basis. The door is equipped with a metal container for small items and a set of 3 hooks for towels and clothes.

All shelves are spaced every 200 mm.

### SPORTS CABINET FOR COACHES

The cabinet has possibility of easy configuration of the following equipment:

- hooks i.e. for jump ropes, hula-hoops,
- shelves (for plastrons),
- frame drawer with dividers (for bow-shaped handles, javelins),
- possibility of mounting on the drawer a compartment for stopwatches, whistles and other small items.

These elements mentioned above are our standard offer and are height adjustable. Perforated door, with the full opening, lockable in 2 points.

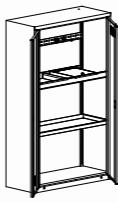

## TECHNICAL SPECIFICATION

		
Designation	Sum 410 sport	Sbm 212 for sports equipment
Code	SUM 0601020102B80	SNSS 11032037
Height (mm)	1800	1990
Width (mm)	400	1200
Depth (mm)	490	500
Number of units	1	1



# SOCIAL FURNITURE

## SPORTS FURNITURE

### LOCKER FOR SKIS AND SKI EQUIPMENT

Cabinet for 2 sets of skis, ski boots and helmets. Wardrobe locker is designed for sports, holiday and ski resorts. It is equipped with a set of 6 hooks for shoes and helmets, the bottom is equipped with galvanized bath-shelf and an upper shelf designed to store goggles and ski gloves.



## TECHNICAL SPECIFICATION

Locker for skis	
Designation	Sum 421 for skis
Code	SUM 0701020201B81
Height (mm)	2140
Width (mm)	800
Depth (mm)	490
Number of units	2





# SOCIAL FURNITURE

## TABLES, BENCHES, CHAIRS AND STANDS

A perfect supplement for changing rooms and social rooms are benches, stands, chairs and tables.



single benches - frame made of tubular steel (ŁO)



single benches - frame made of closed profile (Łsz 3, Łsz 3a)



single benches made of solid wood – folding metal frame (BS)



one-side benches with support and hooks (Łsz 1, Łsz 1a)



double-side benches with support and hooks (Łsz 2, Łsz 2a)

## TECHNICAL SPECIFICATION

Tables, benches, chairs and hangers								
	Designation	Łsz 3	Łsz 3a	Łsz 1	Łsz 1a	Łsz 2	Łsz 2a	
	Code	LSZ 050205	LSZ 060205	LSZ 010101	LSZ 020101	LSZ 030102	LSZ 040102	
	Height (mm)	405		1650				
	Width (mm)	1000	1500	1000	1500	1000	1500	
	Depth (mm)	355		380		730		



Tables, benches, chairs and hangers								
	Designation	KD	ŁO 12	ŁO 16	ŁO 20	Bench BS	Table BS	WPPS 1
	Code	KKD	LO 01010101	LO 02010101	LO 03010201	ŁAWKA BS	STÓŁ BS	PPSW 010101
	Height (mm)	780/450	460	460		480	780	1845
	Width (mm)	460	1200	1600	2000	2200	2200	600
	Depth (mm)	500	440	440		250	600	600
Description	chair	garden bench	garden bench		garden bench	garden table	hanger	



# SCHOOL FURNITURE

## SCHOOL CHAIRS

**STANDARD School chair**  
Size 0-4 K06 5-7 K07,  
frame out of square profile 20x20 mm,  
birch plywood.

**STANDARD School chair with movable desktop**  
Size 5-7 K16,  
frame out of square profile 20x20 mm,  
birch plywood.

**BOLEK School chair**  
size 1-4 Ø 22 mm K08,  
size 5-7 Ø 25 mm K09,  
birch plywood.

**BOLEK School chair with desktop**  
size 1-4 Ø 22 mm K30,  
size 5-7 Ø 25 mm K31,  
birch plywood.

Height scope according to PN-EN 1729:2007-1

Number	Range of height	Colour mark
1	93 - 116 cm	Orange
2	108 - 121 cm	Purple
3	119 - 142 cm	Yellow
4	133 - 159 cm	Red
5	146 - 176,5 cm	Green
6	159 - 188 cm	Blue
7	174 - 207 cm	Brown



STANDARD school chairs



BOLEK school chairs

## VARIOUS TYPES



STANDARD school chair



STANDARD school chair with movable desktop



BOLEK school chair



BOLEK school chair with desktop

# SCHOOL FURNITURE

## SCHOOL DESKS BLACKBOARDS

### DESKS

**STANDARD School desk**  
single, 75x50 cm,  
size: 1-4 S18 5-7 S21,  
frame made of 25x25 mm square profile,  
18 mm thick laminated board,  
1 mm or 2 mm thick PVC veneer.

**STANDARD School desk**  
double, 130x50 cm,  
size: 0-4 S24 5-7 S25,  
frame made of 25x25 mm square profile,  
18 mm thick laminated board,  
1 mm or 2 mm thick PVC veneer.

**STANDARD School desk**  
single, 75x50 cm,  
size: 1-4 Ø 30 mm S104,  
size: 5-6 Ø 30 mm S105,  
double, 130x50 cm,  
size: 1-4 Ø 30 mm S102,  
size: 5-6 Ø 30 mm S103,  
18 mm thick laminated board,  
1 mm or 2 mm thick PVC veneer.  
with adjustable leveling feet.

**School desk with adjustable height**  
size: 0-2, 1-3, 2-4, 3-6, 5-7,  
frame made of 25x25 mm square profile,  
18 mm thick laminated board,  
1 mm or 2 mm thick PVC veneer.  
single 75x50 cm S30,  
double 130x50 cm S23,  
triple 180x50 cm S28,  
with adjustable leveling feet.

### BLACKBOARDS

We offer also white magnetic boards. There is possibility to order blackboards with rulings: check, line, 3-line, stave, ordinates.



STANDARD single school desk,  
frame made of square profile



STANDARD double school desk,  
frame made of square profile



school desk with adjustable height,  
frame made of square profile



STANDARD school desk,  
frame made of Ø 30 mm tubular steel

### BLACKBOARDS



single green board 1700x1000 mm

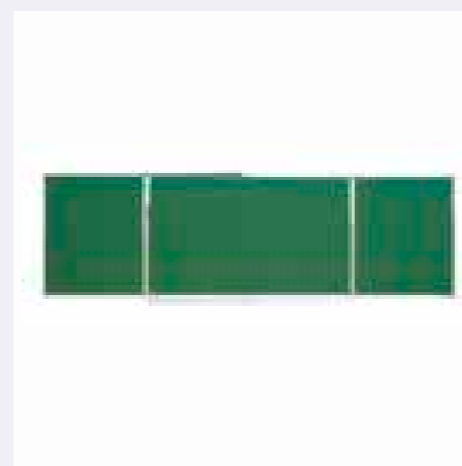

TRYPTYK green board 3400x1000 mm



green board with a stand 1700x1000 mm,  
height of the stand 1980 mm

# SOCIAL FURNITURE

## BESPOKE FURNITURE - examples

In response to market demand we also produce bespoke furniture.

A modern machinery and experienced technical crew allow us to make even the most complicated orders.



## CUSTOMIZED PRODUCTS

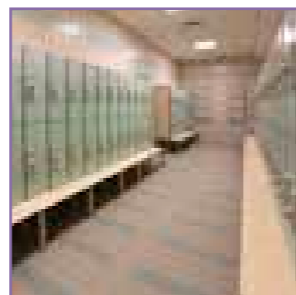

HPL lockers



plexi doors

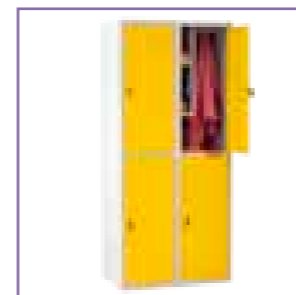

additional partition walls

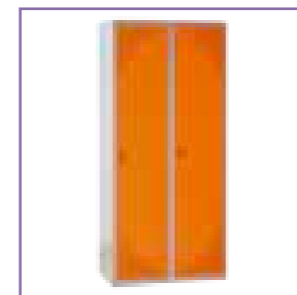

different perforations



different equipment



additional shelves

# SOCIAL FURNITURE

## BESPOKE FURNITURE - examples

In response to market demand we also produce bespoke furniture.

A modern machinery and experienced technical crew allow us to make even the most complicated orders.



## CUSTOMIZED PRODUCTS

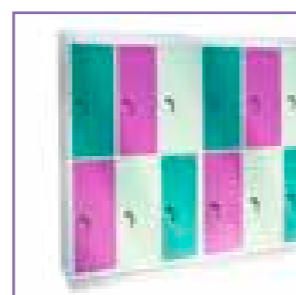

interesting colours



full RAL palette available



curved doors



compartment lockers



rvarious options of lockers

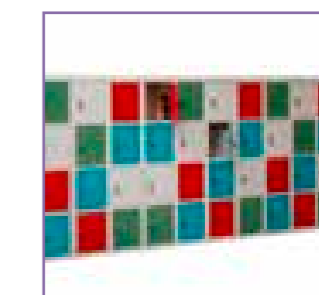

lockers for younger pupils

# MEDICAL FURNITURE

*Furniture  
you can depend on*





# MEDICAL FURNITURE

## CONTENTS

Sml Cabinets for Doctors	190
Szk Filing Cabinets	194
Doctor's Office	198
Szl Medical cabinets	202
Stl Surgery Tables	204
Bedside cabinets	206
Stainless Steel Furniture	208

From range of metal furniture we present you our medical furniture such as: doctor's cabinets, hanging cabinets, surgical tables, tables for dressing materials, bedside cabinets.

The furniture we offer are perfect, high quality equipment for modern doctor's offices, laboratory rooms, scientific research facilities, hospitals, drug stores and other medical rooms.

We also manufacture the furniture made of acid-proof steel.

The possibility of installing wheels on tables and cabinets guarantees the appropriate functional features. The furniture is coated with high chemical resistant powder – in colours according to RAL palette.



Sizes



Drawers on full extension ball bearing slides



Anti-tilt system



Central lock



Height adjustable feet



Possibility of hanging clothes



Elements for levelling



Maximum load capacity of drawers 50 kg



On wheels



Adjustable shelves



5 kg shelf load capacity



25 kg shelf load capacity

# MEDICAL FURNITURE

## SML CABINETS FOR DOCTORS

Cabinets for doctors are ideal for equipping doctor's offices, pharmacies, and other medical rooms. Cabinet doors are filled with tempered glass. Glass shelves are adjustable every 25 mm. The door handle is equipped with a lock which secures the doors in two points.

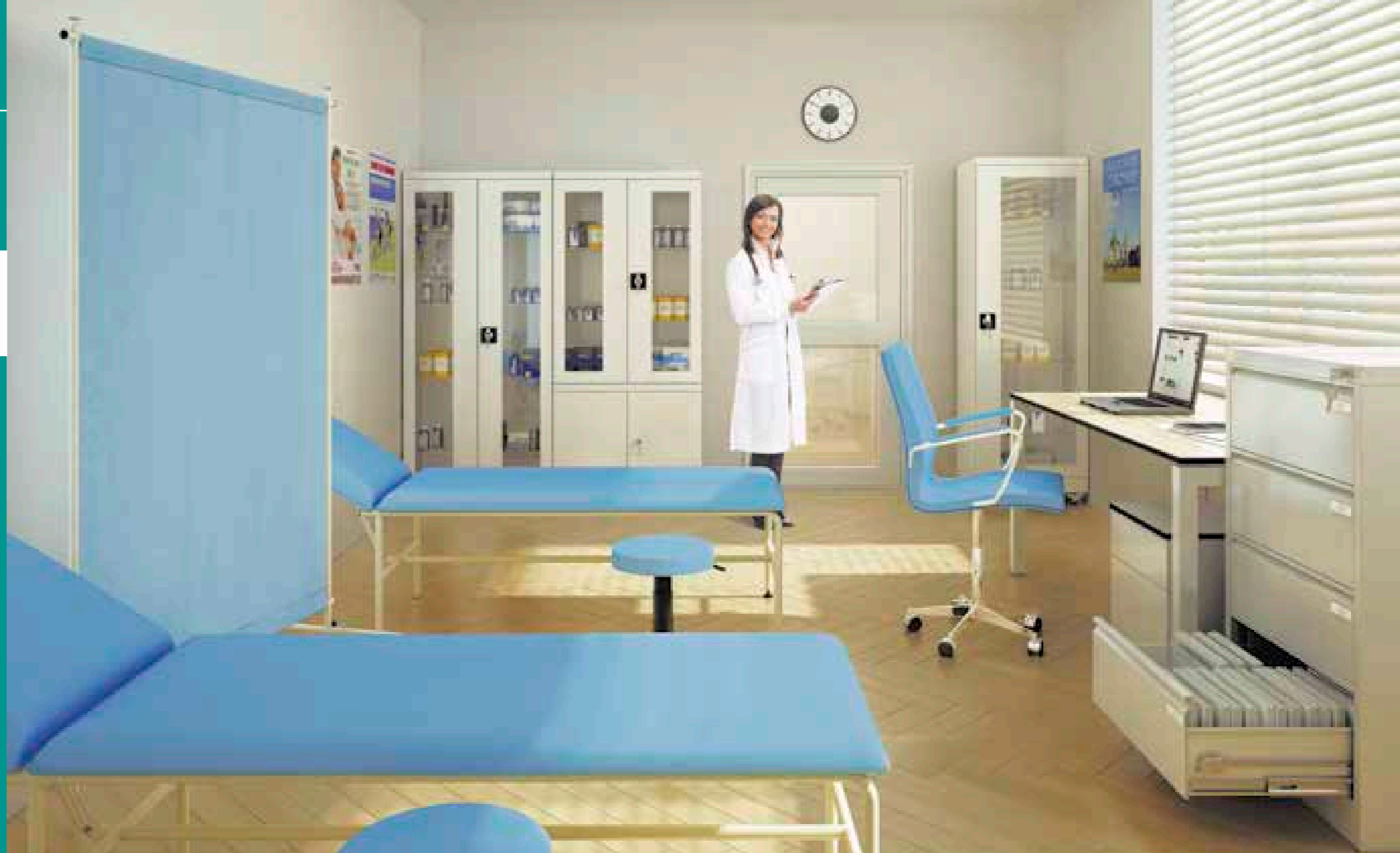

### STANDARD EQUIPMENT

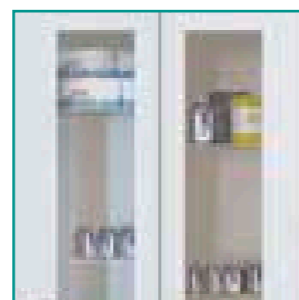

doors with tempered glass



glass shelves – movable every 25 mm

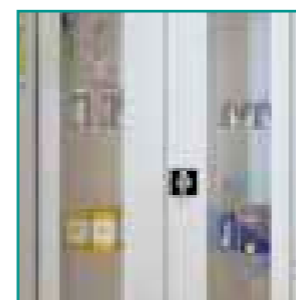

doors locked in 2 points

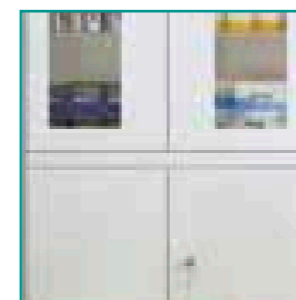

available cabinet with lockable lower compartment



available cabinets on castors









antistatic wheels, swivel, two with brakes, not leaving scuff marks on the floor



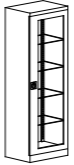



# MEDICAL FURNITURE

## SML CABINETS FOR DOCTORS

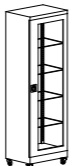
The cabinets are available can be also made of acid-pro-  
of steel, at an extra cost.  
It is possible to order the cabinet on wheels which allow  
for easy movement. Swivel wheels are antistatic, do not  
leave scuff marks on the floor, and two are with brakes.

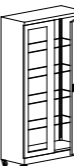
									
Designation	Sml 101	Sml 112		Sml 103	Sml 114	Sml 115	Base	Base	Base
Code	SML 0101020101	SML 0201030101		SML 0301030101	SML 0201050401	SML 0201030701	PSUM 31060101	PSUM 32060101	PSUM 33060101
Height (mm)	1800			1800			140		
Width (mm)	600	800		1000	800		600	800	1000
Depth (mm)	435			435			434		
Equipment	- 4 glass shelves			- 4 glass shelves	- In the lower part of the closed compartment with a glass shelf - In the upper part of the glass shelves	- 4 glass shelves - The sides of the cabinet made of glass	- base consisting of square tube legs - makes cabinets higher by 140 mm - legs equipped with adjustable feet		

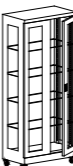
									
Designation	Sml 111	Sml 102		Sml 113	Sml 104	Sml 105			
Code	SML 0101020102	SML 0201030102		SML 0301030102	SML 0201050402	SML 0201030702			
Height (mm)	1890			1890					
Width (mm)	600	800		1000	800				
Depth (mm)	435			435					
Equipment	- wheels - 4 glass shelves			- wheels - 4 glass shelves	- wheels - in the bottom closing compartment - in the upper part glass shelves	- 4 glass shelves			



# MEDICAL FURNITURE

## FILING CABINETS

A5, B6, A6 sizes filing cabinets for are used mostly for patients' cards. Drawers are mounted on double extension ball bearing slides, protected against falling out and with central lock. There are self adhesive cardholders for every drawer.



### ADVANTAGES OF CABINETS



most often used sizes in medicine



drawers' central locking



self adhesive cardholders for each drawer

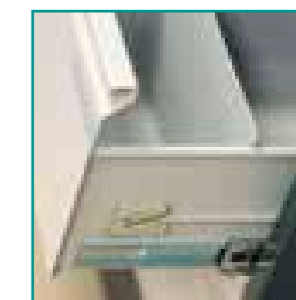

double extension ball bearing slides protected against falling out

# MEDICAL FURNITURE

## FILING CABINETS

A5, B6, A6 sizes filing cabinets for are used mostly for patient cards. Drawers are mounted on double extension ball bearing slides, protected against falling out and with central lock. There are self adhesive cardholders for every drawer.

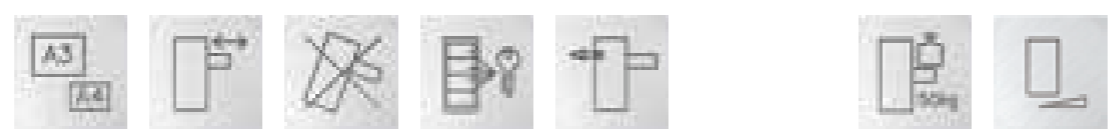
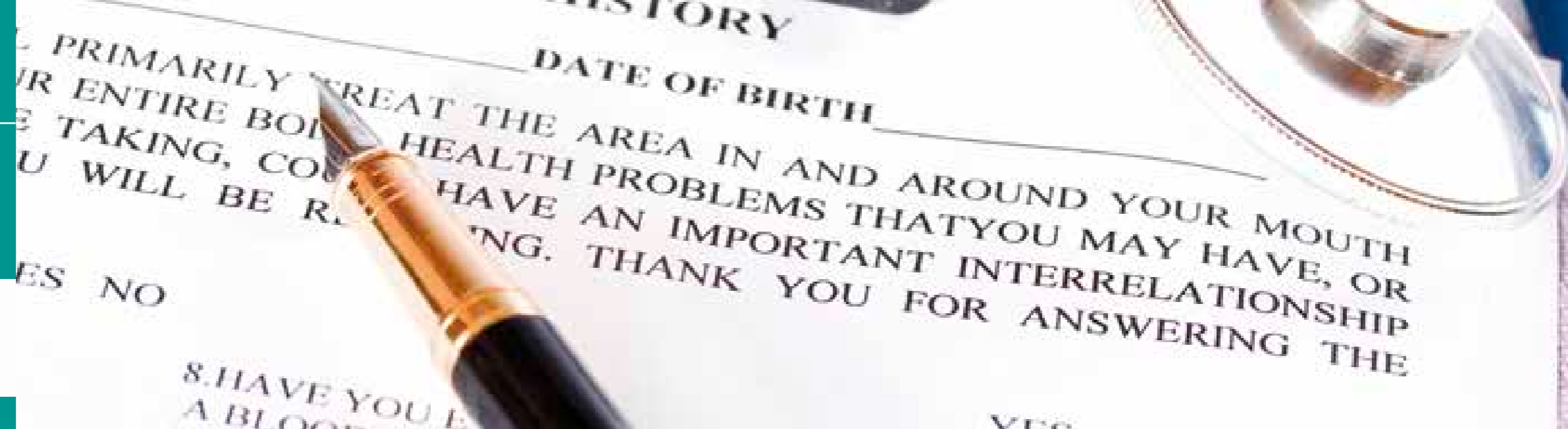

### TECHNICAL SPECIFICATION

Designation	Szk 304/2	Szk 304/3	Szk 304/4	Szk 304	Szk 305	Szk 103	Szk 203	Szk 303
Code	SZK 03063401	SZK 03073501	SZK 03083601	SZK 03031101	SZK 02031301	SZK 02011401	SZK 02021501	SZK 02031601
Height (mm)	605	830	1060	1285	1285	715	1000	1285
Width (mm)	545		545		775	775		
Depth (mm)	630		630		630	630		
Number of drawers	2	3	4	5	5	4	6	8
Number of rows in the drawer	2		2		4	4		
Internal dimensions of drawers	H x W x D 187 (front 223) x 460 x 585		H x W x D 187 (front 223) x 460 x 585		H x W x D 100 (front 223) x 690 x 585	H x W x D 100 (front 137) x 690 x 585		
Sizes	A5 horizontally		A5 horizontally		A5 vertically	A6		

Designation	Szk 318/1/5	Szk 318/2	Szk 318/3	Szk 318/4	Szk 318	Szk 318/6	Szk 318/7	Szk 319
Code	SZK 11035002	SZK 09064502	SZK 09074602	SZK 09084702	SZK 09032102	SZK 09134802	SZK 09154902	SZK 09032202
Height (mm)	1285	605	830	1060	1285	1510	1740	1285
Width (mm)	345	610	610		610	610		610
Depth (mm)	630		630		630	630		630
Number of drawers	5	2	3	4	5	6	7	5
Number of rows in the drawer	1	2	2		2	2		3
Internal dimensions of drawers	H x W x D 150 (front 223) x 262 x 585		H x W x D 150 (front 223) x 262 x 585		H x W x D 150 (front 223) x 262 x 585	H x W x D 150 (front 223) x 262 x 585		H x W x D 150 (front 223) x 522 x 585
Sizes	B5 horizontally		B5 horizontally		B5 horizontally	B5 horizontally		215 x 170 mm



# MEDICAL FURNITURE

## DOCTOR'S OFFICE

Our medical cabinets allow for a complex arrangement of every room. The presented visualizations are just suggestions. The choice is yours.



### EQUIPPING SUGGESTIONS



small, practical desks

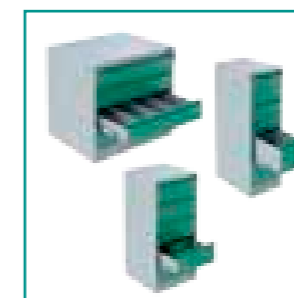

a wide selection of filing cabinets



additional equipment

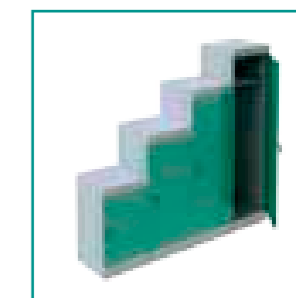

wide range of cabinets

# MEDICAL FURNITURE

## DOCTOR'S OFFICE





We offer two kinds of desks designed for a doctor's office:

- small, highly functional STB desks with mobile pedestals,
- Zbm 304 desks with rounded top and with Szp mobile pedestal.

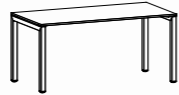
The 'Alicja' furniture set is highly functional as well. The set consists of Zbm desk and Zbm lockers (including one for clothes).

As an addition to medical furniture we offer an exam couch, a stool, and a curtain – indispensable in a doctor's office.

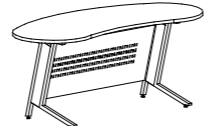

Tables		
Designation	Stb 1060	Stb 1080
Code	MST 0101010101	MST 0601010101
Height (mm)	745+770	
Width (mm)	1000	
Depth (mm)	600	800

Mobile pedestals				
Designation	Szp 520	Szp 530	Szp 630	Szp 640
Code	MSZP 0101010101	MSZP 0101020101	MSZP 0102030101	MSZP 0102040101
Height (mm)	517		662	
Width (mm)	417			
Depth (mm)	556			
Equipment	- 1 higher drawer - 1 small drawer	- 3 small drawers	- 1 high drawer - 2 small drawers	- 4 small drawers

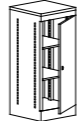
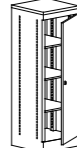
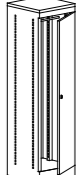
Alicja Furniture set	
Designation	Zbm 304
Code	STBJ 16020705
Height (mm)	740
Width (mm)	1800
Depth (mm)	800
Equipment	-melamine-covered top

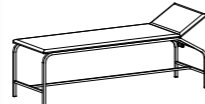
			
Zbm 102	Zbm 104	Zbm 106	Zbm 112
SZB 0101020302	SZB 0102020402	SZB 0103020502	SZB 0104020802
745	1030	1315	1600
435		440	
- 1 adjustable shelf - melamine covered top	- 2 adjustable shelves - melamine covered top	- 3 adjustable shelves - melamine top	- shelf with a bar for hanging clothes - melamine covered top

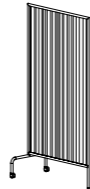
Additional equipment	
Designation	Exam table
Code	KOZETKA
Height (mm)	520
Width (mm)	560
Depth (mm)	1880
Description	- adjustable angle of abutment

	
Curtain	Stool
PARAWANS	TABORET
1850	410-540
1000	diagonal of the seat 350 mm
	diagonal of the seat 600 mm
- n 2 wheels	- 350 mm diameter upholstered top - height adjustable - on wheels

# MEDICAL FURNITURE

## SZL MEDICAL CABINETS

The hanging cupboards make functional equipment for medical facilities or laboratory sites. Szl medical cabinets allow for arranging working space so as to maximize efficiency. They are equipped with sliding glass doors or metal winged doors – with a handle or magnetic lock. The cabinet with metal doors can serve as a first aid kit.

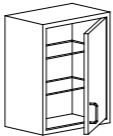
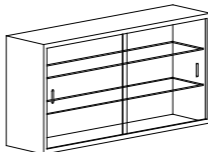

### TECHNICAL SPECIFICATION

Medical cabinets			
Designation	Szi 101	Szi 102	Szi 103
Code	SZL 01010201	SZL 02010401	SZL 03010401
Height (mm)	500	500	
Width (mm)	400	800	1000
Depth (mm)	250	250	
Description	- hanging cabinet with one door having a handle and magnetic - two glass shelves inside	-hanging cabinet with sliding doors - glass doors and shelves	- hanging cabinet with sliding doors - glass doors and shelves

# MEDICAL FURNITURE

## STL SURGICAL TABLES



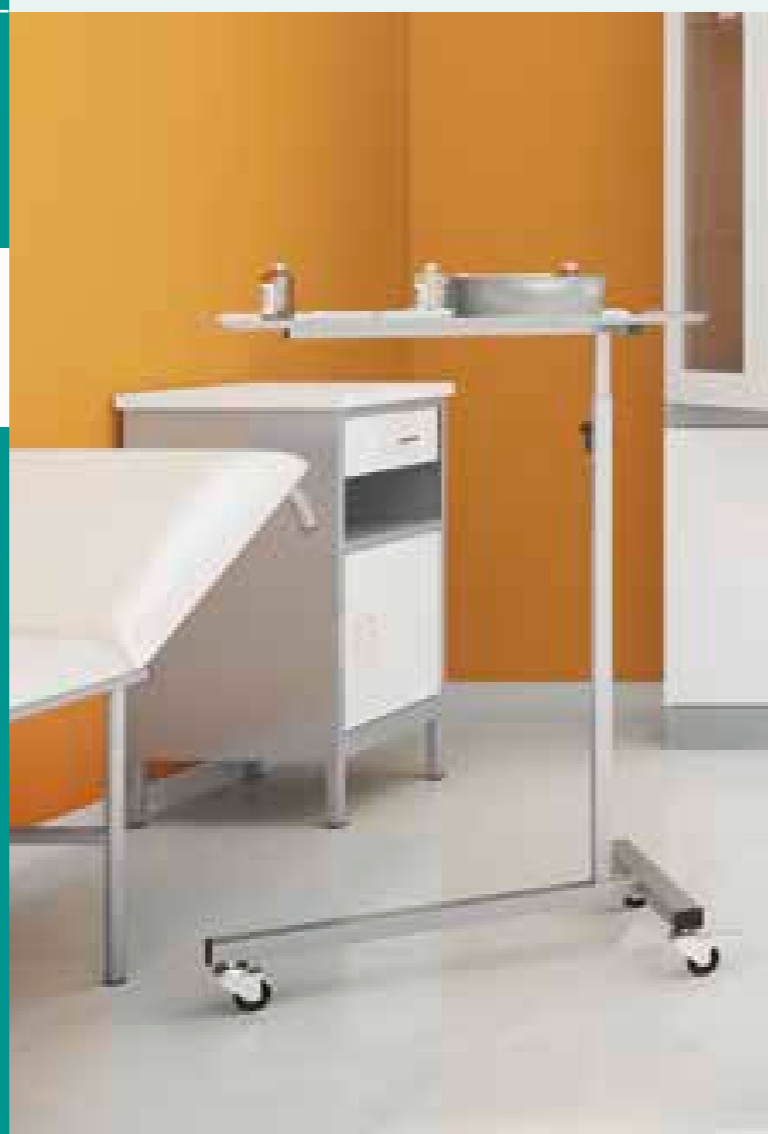

Surgical tables make it easy to transport tools in an operating block.

Wheels allow moving the table and putting it in every place at a doctor's office or operating theatre. All wheels are anti-static, non-marking, swivel, and two of them are with the safety brakes. Maximal load capacity of the table is 50 kg.

Stl 201 surgical instrument table. Acceptable maximum load capacity - 10 kg. Raised and lowered by hand (within the scope of 920 - 1380 mm), dimensions of working top: 600 x of 400 mm. Adjustable top.



### TECHNICAL SPECIFICATION

Surgical table				
Designation	Stl 101	Stl 103	Stl 102	Stl 104
Code	STL 01010201	STL 02010201	STL 01010401	STL 02010401
Height (mm)	880		880	920-1380
Width (mm)	1000	1400	1000	400
Depth (mm)	600		600	600
Description	- surgical table			- surgical instrument table

# MEDICAL FURNITURE

## BEDSIDE CABINETS

Bedside cabinets are the essential equipment of hospital rooms, since they guarantee keeping the area around the patient's bed clean and orderly.

**Szp 1 cabinet** – the simplest and cheapest version of a bedside cabinet.

**Szl 201 bedside cabinet** – The cabinet with simple rotating and lifting mechanism. Symmetrical – the cabinet and its drawers open at both sides.

**Szl 201o bedside cabinet** – professional cabinet with lifting mechanism. There is also a possibility of adjusting the angle of the top.

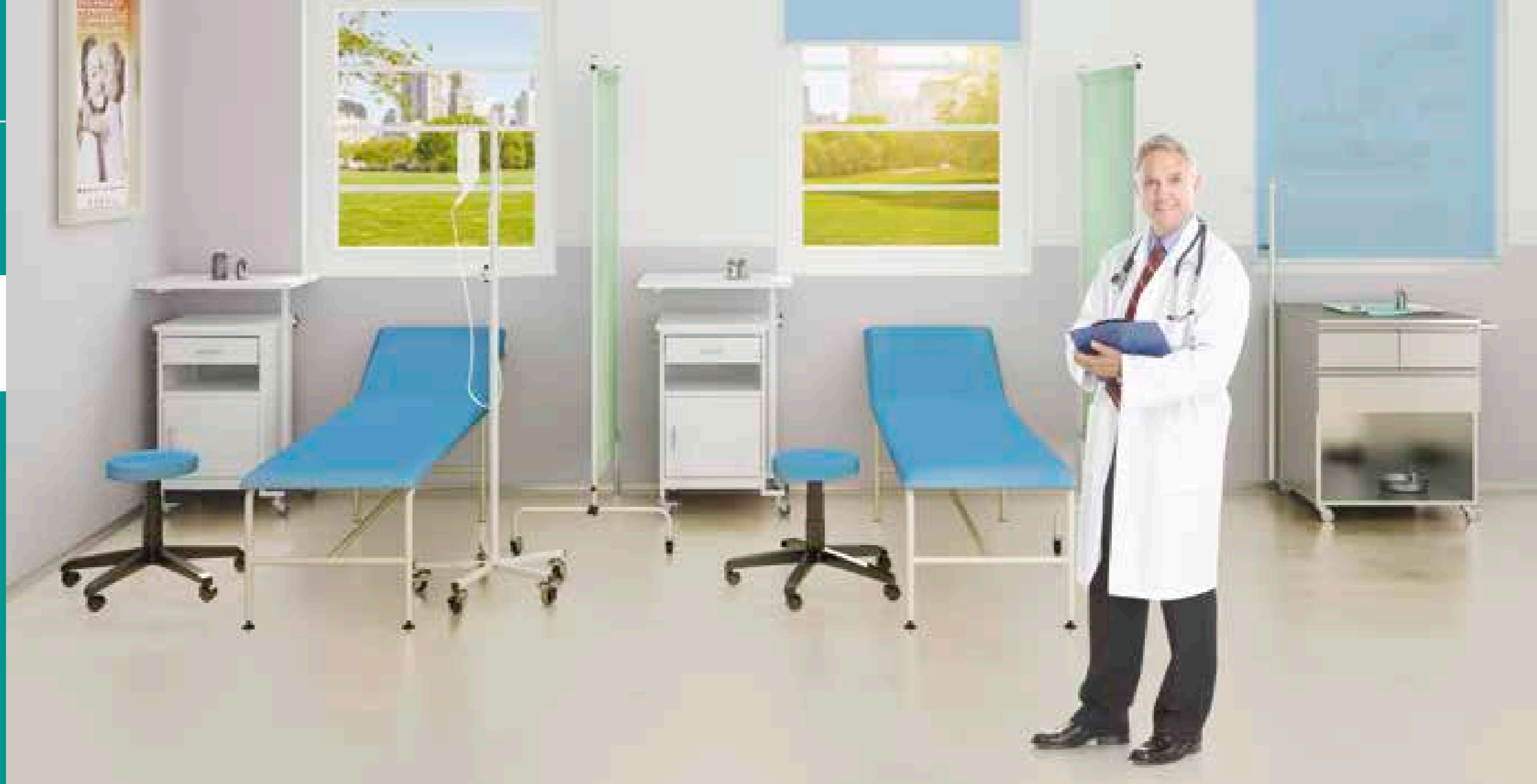

### TECHNICAL SPECIFICATION

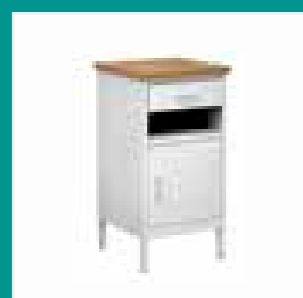

Szp 1



Szl 201

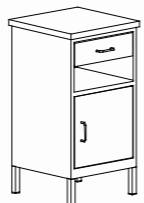
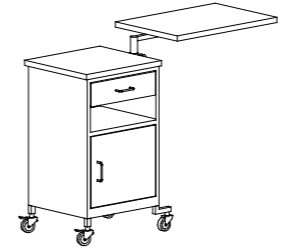
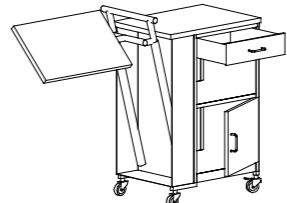

Szl 201o

Bedside cabinets			
	Designation	Szp 1	Szl 201
Code	SZL 0604020601	SZL 0402050402	SZL 0503050502
Height (mm)	800	800	945
Width (mm)	420	610	585
Depth (mm)	420	420	415
Description	Equipped with: - roll bearing slides, - tabletop, - cabinet with a hold.	- a simple tabletop rotating and lifting mechanism	- a lifted tabletop



# MEDICAL FURNITURE

## ACID-PROOF FURNITURE

Acid-proof furniture ensure maintaining cleanness and sterility, long-term durability, aesthetics and high quality. Those are for professional applications as well as increasingly for rooms for allergy sufferers.

**Surgical instrument table.** With manually adjusted tray within the scope of 911 – 1370 mm, size of 600x400 mm. Rotating tray with the possibility of blocking in every position. Maximum load capacity is 10 kg.

**The emergency table** is intended for moving the sterile materials, baskets, tools, drugs and other equipment around an operation block, hospital departments, emergency rooms, laboratories and sterilization rooms.



**Cabinet for anaesthetics** is equipped with a stand for liquids. The stand is adjustable in the range of 1300 – 2100 mm.

**Stand for liquids** – five-arm base, the upper part equipped with 4 hooks made of stainless rods. The stand is adjustable in the scope of 1300 – 2200 mm.

**Operating platform** – steps are covered with anti-slide strips (made of material resistant to water, oil and UV radiation). Platform ensures the ergonomic working conditions during an operation.

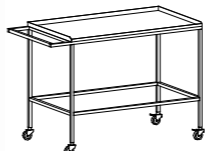
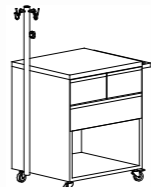

### TECHNICAL SPECIFICATION

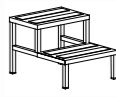
					
	Std	Stlk	Szla	Wmk	Two-step operating platform
Designation	Std	Stlk	Szla	Wmk	Two-step operating platform
Code	STLN 03020602	STLN 02010204	SZLN 0907011102	SJLN 01010101	SLN 010101
Height (mm)	911-1370	880	840	1360-2340	430
Width (mm)	460	1400	770	575	500
Depth (mm)	630	600	600	575	650

# WORKSHOP FURNITURE

*Furniture  
you can depend on*



# WORKSHOP FURNITURE

## CONTENTS

STW Workshop tables	214
SZW Workshop cabinets	216
SZW Workshop cabinets for tools	218
SZWG Workshop cabinets	220
SWM Workshop cabinets	222
RMM Storage racks	224
SLS Workshop cabinets	226
SL Workshop cabinets	228
SFR Workshop cabinets	232
Workshop cabinets	234
TECHNO Workbenches	238
SMD Workshop cabinets	
UWS Workshop cabinets	
WWT Workshop trolleys	240
Accessories	244
Industrial computer cabinets	248

During the design and manufacturing process, we care about all the details: order, safety, versatility, functionality, ergonomics, design and most importantly - people and their needs at the workstation. Our workshop cabinets, trolleys, boxes, workbenches, tool walls and industrial computer cabinets due to their high quality, functionality and durability will surely meet your expectations.

Our workshop furniture allow for practical arrangement of every workstation. Every piece of workshop furniture is made of powder coated steel protected from corrosion. Colours according to RAL palette.

It is also possible to customize the construction and colours according to the client's individual needs.



For self-assembly



Various types of locks



Regulated levelling feet



Loading capacity of evenly loaded table – 450 kg



On wheels



Loading capacity of evenly loaded table – 600 kg



Load capacity of shelf – 15 kg



Loading capacity of evenly loaded table – 900 kg



Load capacity of shelf – 20 kg



Loading capacity of evenly loaded table – 1350 kg



Load capacity of shelf – 50 kg



Product with electrical components - safe



Load capacity of shelf – 75 kg

# WORKSHOP FURNITURE

## STW WORKSHOP TABLES

Our STW workshop tables combine high quality, strength and functionality.

STW Workshop tables are designed for mechanical workshops, tool departments, as well as small mechanical workshop and individual clients.

Workshop tables in combinations with metal cabinets, tool walls and storage racks provides great work organization.

Their diversity guarantees that they are perfectly fitted to the customer's individual needs.



### TECHNICAL SPECIFICATION

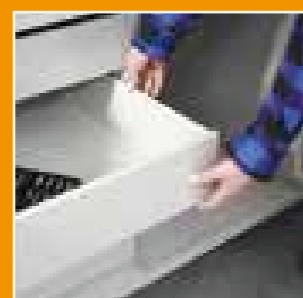

Workshop tables								
	Designation	Stw 111	Stw 121	Stw 321	Stw 322	Stw 323	Stw 324	Stw 311
	Code	STWS 01010201	STWS 02010202	STWS 02010103	STWS 02010104	STWS 02010305	STWS 02010306	STWS 01010207
	Height (mm)	850		850				
	Width (mm)	600	1200	1200	1200	1200	1200	600
	Depth (mm)	600		600				
Dimensions of tabletop in mm (h x w x d)	30 x 600 x 600	30 x 1200 x 600	30 x 1200 x 600	30 x 1200 x 600	30 x 1200 x 600	30 x 1200 x 600	30 x 600 x 600	



Workshop tables										
	Designation	Stw 122	Stw 112	Stw 113	Stw 114	Stw 401	Stw 402	Stw 403	StbG 45	StbG 47
	Code	STWS 02020211	STWS 01020207	STWS 01020212	STWS 01020113	STWS 04010209	STWS 05010310	STWS 06010310	GST 02020202	GST 01010201
	Height (mm)	750		850					725 - 920	900
	Width (mm)	1200	600	600	600	1200	1600	200	1200	1000
	Depth (mm)	600		600		750			600	
Dimensions of tabletop in mm (h x w x d)	30 x 1200 x 600	30 x 600 x 600	30 x 600 x 600	30 x 600 x 600	40 x 1200 x 750	40 x 1600 x 750	40 x 2000 x 750			

# WORKSHOP FURNITURE

## SZW WORKSHOP CABINETS

Due to easy access to the tools, workshop cabinets allow to keep the workstation in order.

Perforated internal walls allow for easy hanging holders, brackets and hooks for tools.

Szw 104 and Szw 108 workshop cabinets are equipped with drawers and shelves on roll bearing slides and a work desk on the top of the box.

Workshop cabinets (except Szw 104 and Szw 108) are delivered in elements.



### TECHNICAL SPECIFICATION

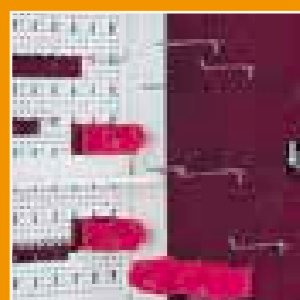

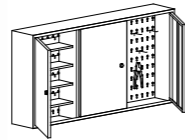
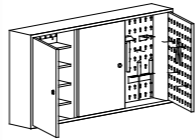
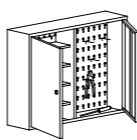
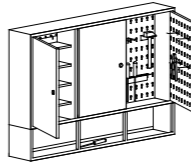
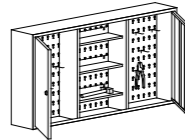
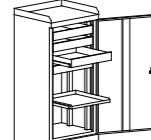
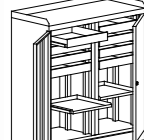
Workshop boxes							
Designation	Szw 120	Szw 121	Szw 080	Szw 122	Szw 123	Szw 104	Szw 108
Code	SZWS 02010201	SZWS 02010302	SZWS 01010103	SZWS 02020304	SZWS 02010205	SZW 0101010101	SZW 0201020201
Height (mm)	600	600	600	750	600	1090	1090
Width (mm)	1200	1200	800	1200	1200	500	1000
Depth (mm)	2000	200	200	200	200	435	435
Equipment	- 8 galvanized hooks - 145, 120, 85 mm each - 4 shelves	- 9 holders - wrench holder (1), drill holder (1), screwdriver holder (1), handle with single cut (1), holder with double cut (2), holder with oval cut (2) - 2 hooks - 85, 120, 145 mm each - backside of the doors have perforation	- 8 galvanized hooks - 145, 120, 85 mm each, 6 hooks of 120 mm long - 4 shelves	- 6 holders from 0.8 mm steel sheet, three holders from 1.5 mm steel sheet-wrench holder (1), drill holder (1), screwdriver holder (1), chisel holder (1), file holder (1), screwdriver open holder (1), holder with single cut (1), holder with double cut (1), holder with oval cut (1); two galvanized hooks - 4 shelves	- 5 galvanized hooks - 145, 120, 85 mm each, 3 shelves - middle part of the box without doors	- 4 drawers and shelf mounted on roll bearing slides - the top serves as a stand with edges on three slides - extendable shelf	- 8 drawers and two shelves mounted on roll bearings slides - the top serves as a stand with edges on three sides - 2 extendable shelves



# WORKSHOP FURNITURE

## SZW WORKSHOP LOCKERS FOR TOOLS

### ŚNN TOOL WALLS

It is essential to have the most necessary tools within reach. This can be ensured by our tool walls. Tool walls for self assembly.

### SZWN WORKSHOP TROLLEY

The workshop trolleys are equipped with:

- tops made from hardwood plywood,
- all drawers locked with central lock,
- drawers on ball bearing slides (maximum load capacity of 50 kg per drawer),
- doors locked with a cylindrical lock,
- two swivel wheels.

### SZWG CABINET

Workshop locker on swivel wheels (2 with brakes). The top part made of perforated steel sheet (back and side walls), the bottom part with a shelf and 2 drawers. Set of hooks - according to the client's needs (at an extra cost).

### SZW WORKSHOP CABINET WITH DRAWERS

Szw lockers provide stable construction, central lock, anti tilt system (preventing from opening more than one drawer at a time).

Maximum load capacity per drawer: 75 kg.

On customer's request the top can be covered with: rubber, plywood in metal frame or acid-proof steel sheet.

Drawer partitions are also available, allowing for dividing the drawer into 5 rows. Every row is equipped with 2 galvanized partitions.

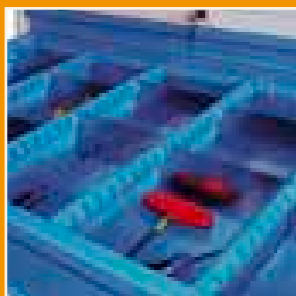



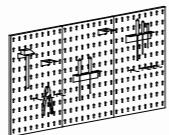

## TECHNICAL SPECIFICATION

Tool walls	
Designation	Śnn 300
Code	SNN 010101
Height (mm)	600
Width (mm)	1195
Depth (mm)	16
Equipment	-base board – 3 pcs, single hook (58 mm) -5 pcs, long slot holder for the screwdrivers – 1 pc, holder with circular holes – files – 1 pc, holder with rectangular holes – chisels – 1 pc, holder for a drill – 1 pc, holder for the wrench – 1 pc, holder with circular holes for screwdrivers – 1 pc, holder for V container – 2 pcs, single holder – 4 pcs.

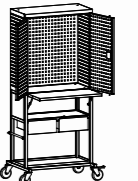

Szw 301

Workshop trolleys			
Designation	SzwN 251	SzwN 252	SzwG 43
Code	GWJ 0101020702	GWJ 0101010802	GWJ 03020306
Height (mm)	928		1930
Width (mm)	961		815
Depth (mm)	600		600
Equipment	5 drawers (including one deep drawer)	10 drawers (including 2 deep drawers)	- On wheels – the top part made of perforated steel sheet (back and side walls). The bottom part with a shelf and 2 drawers.

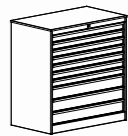
Workshop cabinets with drawers			
Designation	Szw 301	Szw 302	Szw 305
Code	SZWL 0202010201	SZWL 0202010301	SZWL 0202010601
Height (mm)	1051	1051	1051
Width (mm)	1000	1000	1000
Depth (mm)	585	585	585
Height of drawers (mm)	width: 903 x depth: 435	width: 903 x depth: 436	width: 903 x depth: 437
Height of front	1 drawer 175 mm 2 drawers 225 mm 1 drawer 275 mm	1 drawer 75 mm 2 drawers 125 mm 2 drawers 175 mm 1 drawer 225 mm	7 drawers 75 mm 3 drawers 125 mm



# WORKSHOP FURNITURE

## SZWG WORKSHOP CABINETS

It is a very practical workshop set consisting of a cabinet, (back wall, side and doors perforated inside) and the base-rack with 3 shelves. 180 degrees doors opening angle. Hangers, handles and hooks available separately - offer page 244.

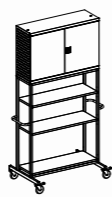
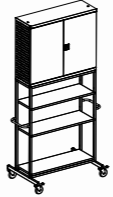

### TECHNICAL SPECIFICATION

SzwG workshop cabinet		
Designation	SzwG43	SzwG43
Code	GWJ 0302030600S08	GWJ 0302030600S09
Height (mm)	2500	2700
Width (mm)	1200	1200
Depth (mm)	800	800
Equipment	- 800 mm high cabinet - base with 3 shelves	- 1000 mm high cabinet - base with 3 shelves

# WORKSHOP FURNITURE

## SWM WORKSHOP CABINETS

### SWM WORKSHOP CABINETS

Anyone can find a suitable cabinet for storing any kind of equipment in their workshop. Extremely strong and practical metal workshop cabinets perform well under any conditions. The height of shelves is adjustable due to mounting holes punched every 25 mm. Door handles are equipped with a 2 point block ing lock. SWM 205 cabinet with containers allow to sort even the smallest elements.

### SWM 501 WORKSHOP CABINET

Winged doors. Inside there is a perforated wall, 2 drawers, 2 shelves adjustable every 25 mm. Set of hooks – set individually (at an extra cost).



### TECHNICAL SPECIFICATION

Workshop Cabinets							
Designation	Swm 402	Swm 404	Sbm 203W	Sbm 212W	Swm 204	Swm 205	Swm 501
Code	SWMS 03020303	SWMS 04020303	SBM 03030304	SBM 04030304	SWM 0202030401	SWM 0202030402	SWML 01020204
Height (mm)	1980		1990		1990	1990	2000
Width (mm)	1000	1200	1000	1200	1000	1000	1020
Depth (mm)	420		435		435	435	435
Description	- self-assembly cabinets - 4 shelves		- 4 shelves adjustable every 25 mm		Workshop cabinet designed to be equipped with containers: - there are strips on the back wall of the cabinet, made for hanging 72 tool boxes (of dimensions as follows: 108x144x224/170 mm) - there are metal strips on the doors of the cabinet for hanging 80 tool boxes (dimensions: 6x77x119/90 mm) -containers are not included	Workshop cabinet with containers: - there are strips on the back wall of the cabinet, made for hanging 72 tool boxes (dimensions: 108x144x224/170 mm) - there are metal strips on the doors of the cabinet made for hanging 80 tool boxes (dimensions: 6x77x119/90 mm)	- perforated wall - 2 shelves - locker - 2 shelves



Swm 501

# WORKSHOP FURNITURE

## RMM STORAGE RACKS

Universal storage racks are essential everywhere where there are different objects stored, such as tools, cartons etc.

In order to shorten the time-consuming assembly of storage racks we designed racks assembled without screws. They are simple and easy to assemble and disassemble. Durability, solidity and quality are unique qualities of these storage racks. Elements of storage racks are made of powder coated metal sheets.

It is also possible to order storage racks made of galvanized acid-resistant steel.

In rack assembled with screws shelves are adjustable every 60 mm, and every 30 mm in racks assembled without screws.

Storage racks for self-assembly.

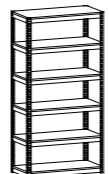
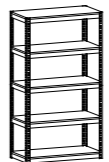
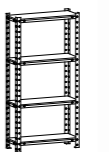
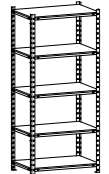

### TECHNICAL SPECIFICATION

Storage racks					
Designation	Rmm 302	Rmm 301	Rmm 303	Rmm 202	Rmm 201
Code	RMM 0301010201	RMM 0303040201	RMM 0305030201	RMM 0102020101	RMM0204030101
Height (mm)	900	1980	1800	1510	2000
Width (mm)	1000	1000		750	900
Depth (mm)	500	500		300	600
Number of shelves	3	6	5	4	5
Assembly with screws				+	+
Assembly without screws	+	+	+		
Load capacity (kg)	200	200		100	

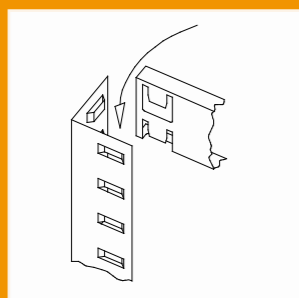

Assembly of snap-fit racks

# WORKSHOP FURNITURE

## SLS WORKSHOP CABINETS

SLS Workshop cabinets are delivered as welded construction.  
They do not require assembly by a customer.  
Drawer's extension - 100%  
Shelves are galvanized, powder-coated.  
Shelf's load capacity – up to 160 kg.  
Load capacity of 150 mm, 125 mm, 100 mm drawers – 160 kg

75 mm drawer's load capacity - 100 kg.  
Load capacity of the whole cabinet - 1300 kg.

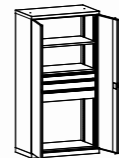
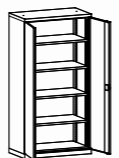
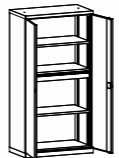
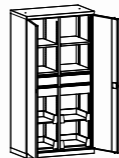
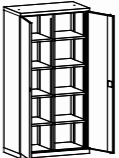
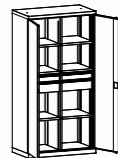
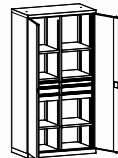

### TECHNICAL SPECIFICATION

SLS Workshop cabinet							
Designation	SLS 1951-7VA	SLS 1951-6	SLS 1951-8VA	SLS 1951 T-1VA	SLS 1951 T-2	SLS 1951 T-3VA	SLS 1951 T-4VA
Code	SLS 0303022307	SLS 0303021605	SLS 0303022407	SLS 0403022607	SLS 0403022005	SLS 0403022707	SLS 0403022808
Height (mm)	1950	1950	1950	1950	1950	1950	1950
Width (mm)	1000	1000	1000	1000	1000	1000	1000
Depth (mm)	540	540	540	540	540	540	540
Equipment	- 2 shelves - 3 drawers (150 mm, 125 mm, 100 mm)	- 4 shelves	- 3 shelves - 1 drawer 100 mm	- divided partition wall - 4 shelves - 4 drawers 150 mm - 4 pullout shelves	- divided partition wall - 8 shelves	- divided partition wall - 6 shelves - 2 drawers 150 mm - 2 drawers 100 mm	- divided partition wall - 4 shelves - 4 drawers 100 mm - 2 drawers 75 mm

# WORKSHOP FURNITURE

## SL WORKSHOP CABINETS

SL workshop cabinets are very practical furniture equipped with shelves, drawers with handles and compartments.

- Shelves' load capacity - 75 kg
- Drawers' load capacity - 35 kg
- Cabinets' load capacity - 800 kg
- Powder coated galvanized shelves.
- Drawer's extension - 85%.
- Ball-bearing slides.



### CABINETS' ADVANTAGES



closed compartments

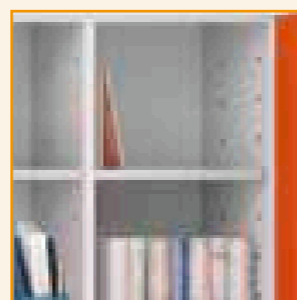

adjustable shelves

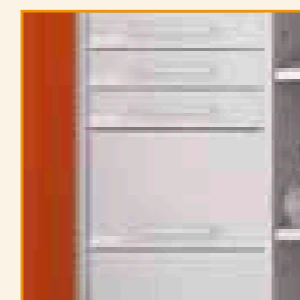

100 mm, 150 mm, 300 mm  
drawers

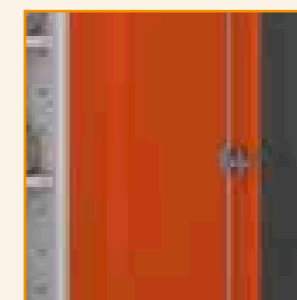

3 point doors locking

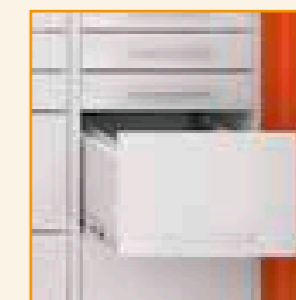

drawers with handles





# WORKSHOP FURNITURE

## SL WORKSHOP CABINETS

Workshop cabinets							
	Designation	SL 110.18	SL 110.21	SL 162.18	SL 162.21	SL 163.18	SL 163.21
	Code	SSCH1 0202034206	SSCH1 0302034206	SSCH1 0202032306	SSCH1 0302032306	SSCH1 0202032506	SSCH1 0302032506
	Height (mm)	1950		1950		1950	
	Width (mm)	1000	1200	1000	1200	1000	1200
	Depth (mm)	500		500		500	
Equipment	<ul style="list-style-type: none"> <li>- divided partition wall</li> <li>- 6 shelves</li> <li>- 4x 300 mm high drawers</li> </ul>		<ul style="list-style-type: none"> <li>- divided middle wall</li> <li>- 8 shelves</li> <li>- 12 drawers 100 mm</li> </ul>		<ul style="list-style-type: none"> <li>- divided middle wall</li> <li>- 4 shelves</li> <li>- 4x 300 mm high drawers</li> <li>- 8 drawers 100 mm</li> </ul>		

Workshop cabinets									
	Designation	SL 164.18	SL 164.21	SL 166.18	SL 166.21	SL 168.18	SL 168.21	SL 165.13	SL 165.15
	Code	SSCH1 0202032406	SSCH1 0302032406	SSCH1 0202032606	SSCH1 0302032606	SSCH1 0202032806	SSCH1 0302032806	SSCH1 0203032106	SSCH1 0303032106
	Height (mm)	1950		1950		1950		1600	
	Width (mm)	1000	1200	1000	1200	1000	1200	1000	1200
	Depth (mm)	500		500		500		500	
Equipment	<ul style="list-style-type: none"> <li>- divided partition wall</li> <li>- 4 shelves</li> <li>- 5x 100 mm high drawers</li> <li>- 1x 300 mm high drawer</li> <li>- 2x 300 mm high closed compartments</li> </ul>		<ul style="list-style-type: none"> <li>- divided middle wall</li> <li>- 4 shelves</li> <li>- 15 drawers</li> <li>- closed compartment 300 mm</li> </ul>		<ul style="list-style-type: none"> <li>- divided middle wall</li> <li>- 4 shelves</li> <li>- closed compartment 300 mm</li> <li>- 9 drawers 100 mm</li> <li>- 2x 300 mm high drawers</li> </ul>		<ul style="list-style-type: none"> <li>- divided middle wall</li> <li>- 2 shelves</li> <li>- 4x 300 mm high drawers</li> <li>- 8 drawers 100 mm</li> </ul>		

Workshop cabinets									
	Designation	SL 168.13	SL 168.15	SL 162.03	SL 162.06	SL 163.03	SL 163.06	SL 167.03	
	Code	SSCH1 0203032206	SSCH1 0303032206	SSCH1 0201031906	SSCH1 0301031906	SSCH1 0201032006	SSCH1 0301032006	SSCH1 0201035106	
	Height (mm)	1950		1000		1000		1000	
	Width (mm)	1000	1200	1000	1200	1000	1200	1000	
	Depth (mm)	500		500		500		500	
Equipment	<ul style="list-style-type: none"> <li>- divided partition wall</li> <li>- 3 shelves</li> <li>- 2x 300 mm high drawers</li> <li>- 7x 100 mm high drawers</li> <li>- 1x 150 mm high drawer</li> </ul>		<ul style="list-style-type: none"> <li>- divided middle wall</li> <li>- 2 shelves</li> <li>- 2x 300 mm high drawers</li> <li>- 4 drawers 100 mm</li> </ul>		<ul style="list-style-type: none"> <li>- divided middle wall</li> <li>- 2 shelves</li> <li>- 2 drawers 100 mm</li> <li>- 2 drawers 150 mm</li> </ul>		<ul style="list-style-type: none"> <li>- divided middle wall</li> <li>- 4x 300 mm high drawers</li> <li>- 2 drawers 100 mm</li> <li>- 2 drawers 150 mm</li> </ul>		



# WORKSHOP FURNITURE

## SFR WORKSHOP CABINETS

Workshop cabinets with compartments are available with and without doors.

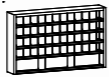
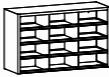
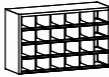
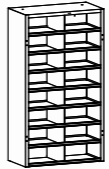
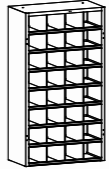
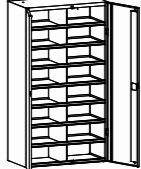
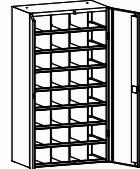

### TECHNICAL SPECIFICATION

SFR workshop cabinets							
Designation	SFR 51/1	SFR 12/1	SFR 24/1	SFR 16/1	SFR 32/1	SFR 16/2	SFR 32/2
Code	SFR 0302010500S5	SFR 0202010300S4	SFR 0202010400S3	SFR 0101010100S1	SFR 0101010200S2	SFR 0101020100S6	SFR 0101020200S7
Height (mm)	900	900	900	1800	1800	1800	1800
Width (mm)	1500	1500	1500	1000	1000	1000	1000
Depth (mm)	250	500	500	500	500	500	500
Number of compartments	- 48 small compartments - 3 large compartments	12	24	16	32	16	32
Compartments' dimensions	121 x 109 x 250 mm 175 x 466 x 250 mm	175 x 466 x 500 mm	175 x 237 x 500 mm	180 x 455 x 500 mm	180 x 222 x 500 mm	180 x 455 x 500 mm	180 x 222 x 500 mm

# WORKSHOP FURNITURE

## WORKSHOP CABINETS

Cabinets can be equipped with:

- adjustable shelves,
- drawers,
- a compartment,
- boxes,
- perforated wall (hooks and hangers available separately).

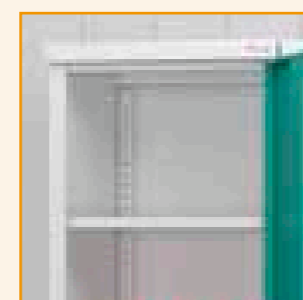

adjustable shelves

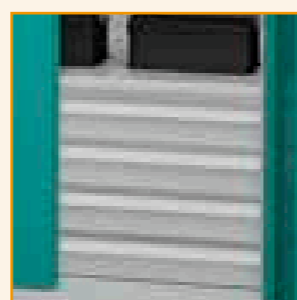

drawers

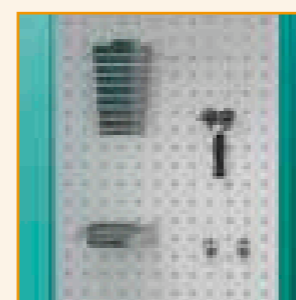

perforated wall

CABINETS' ADVANTAGES



# WORKSHOP FURNITURE

## WORKSHOP CABINETS

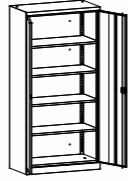
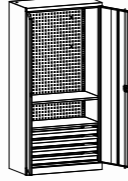
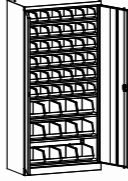
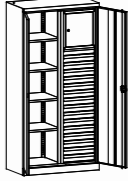
Workshop cabinets					
Designation	SWM201		SWM201L1	SWM201L2	SWM201L
Code	SWM0403030306S48		SWM0403030106S21	SWM0403030106S22	SWM0403030106S18
Height (mm)	1950		1950	1950	1950
Width (mm)	950		950	950	950
Depth (mm)	500		500	500	500
Equipment	4 adjustable shelves		- 2 adjustable shelves - 4 drawers - perforated wall	- 8 adjustable shelves - 48 containers	- 4 adjustable shelves - 16 drawers - a compartment

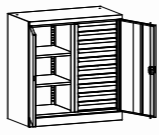
Workshop cabinets			
Designation	SWM101A3		SWM 101L1
Code	SWM0404030207S41		SWM0404030106S20
Height (mm)	1000		1000
Width (mm)	950		950
Depth (mm)	500		500
Equipment	- 2 adjustable shelves		- 2 adjustable shelves - 10 drawers

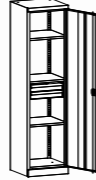
Workshop cabinets	
Designation	SWM201L3
Code	SWM0503021607
Height (mm)	1950
Width (mm)	500
Depth (mm)	500
Equipment	- 3 adjustable shelves - 2 drawers



# WORKSHOP FURNITURE

## TECHNO WORKBENCHES

We also offer professional workbenches:

- Techno Expert workbenches
- Techno Light workbenches

Workbenches for self assembly.

Due to the modular construction and two lines, Techno Workbenches offer the possibility to create a workbench in hundreds of combinations according to your needs:

- Techno Expert Workbenches - designed for professional applications,
- Techno Light Workbenches. - designed for professional as well as amateur applications.

Ask for the detailed catalogue of Techno Workbenches.



WWT



# WORKSHOP FURNITURE

SMD WORKSHOP CABINETS  
UWS WORKSHOP CABINETS  
WWT WORKSHOP TROLLEYS



## CABINETS' ADVANTAGES



desktop

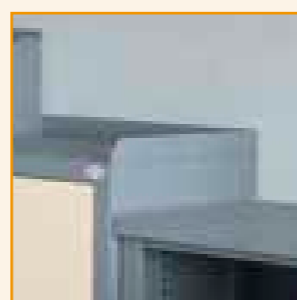

side edge

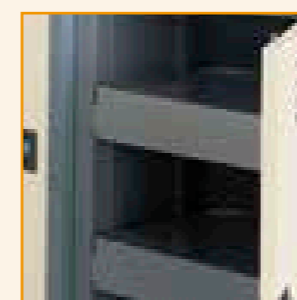

galvanized shelves  
with edges

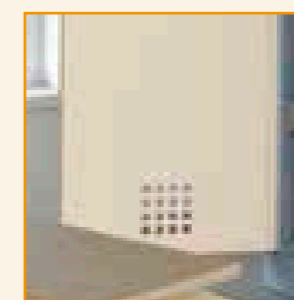

perforation on the door



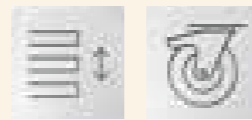





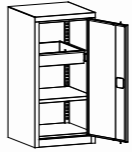
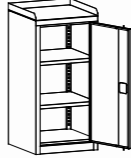
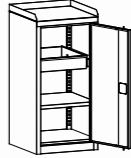
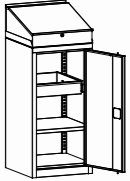

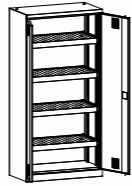
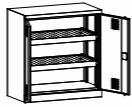
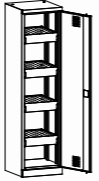
# WORKSHOP FURNITURE

SMD WORKSHOP CABINETS  
UWS WORKSHOP CABINETS  
WWT WORKSHOP TROLLEYS

Workshop cabinets					
Designation	SMD 515/1	SMD 515/2	SMD 515/3	SMD 515/4	SMD 515/5
Code	SZW 0302010703	SZW 0302010803	SZW 0303010703	SZW 0303010803	
Height (mm)	1000	1000	1050	1050	1255
Width (mm)	500	500	500	500	500
Depth (mm)	500	500	500	500	500
Equipment	- 2 shelves	- 1 shelf - 1 drawer	- side edge - grooved rubber - 2 galvanized shelves	- side edge - grooved rubber - 1 drawer - 1 galvanized shelf	- side edge - pulpit - 1 drawer - 1 galvanized shelf

Workshop cabinets				
Designation	UWS 905	UWS 915	UWS 505	UWS 515
Code	UWS 0202060201	UWS 0201060101	UWS 0102050201	UWS 0101050101
Height (mm)	1950	1000	1950	1000
Width (mm)	950	950	500	500
Depth (mm)	500	500	500	500
Equipment	- 4 adjustable galvanized shelves with edges	- 2 adjustable galvanized shelves with edges	- 4 adjustable galvanized shelves with edges	- 2 adjustable galvanized shelves with edges

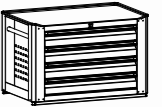
WWT Workshop trolleys					
Designation	WWT 75A	WWT 75B	WWT 75C	WWT 75D	WWT top cabinet
Code	WWT 0101010102	WWT 0101010202	WWT 0101010302	WWT 0101020401	XXXP 030042
Height (mm)	900		900		516
Width (mm)	790		790		790
Depth (mm)	490		490		490
Equipment	1x 300 mm high drawer 2x 100 mm high drawer 2x 75 mm high drawer	1x 200 mm high drawer 1x 150 mm high drawer 4x 75 mm high drawer	1x 200 mm high drawer 6x 75 mm high drawer	winged doors 2 adjustable shelves	4 x 100 mm high drawer





# WORKSHOP FURNITURE

## ACCESSORIES

Designation	Short double hanger L50	Long double hanger L150	Short single hanger L50	Short single hanger	Flat wrench hanger
Code	YMIN282	YMIN281	YMIN284	YMIN283	YMIN493
Description	Short double hanger	Long double hanger	Short single hanger	Long single hanger	Flat wrench hanger

Designation	Screwdriver hanger	Screwdriver hanger	Tool hanger L150	Gear Hanger $\phi$ 60 mm
Code	YMIN492	YMIN491	YMIN499	YMIN490
Description	Screwdriver hanger	Screwdriver hanger	Tool hanger	Gear hanger, for example, for a drill



Designation	Workshop container S1/h45 - LOW	Workshop container S1/h63 - HIGH	Workshop container S2/h45 - LOW	Workshop container S2/h63 - HIGH	Workshop container S3/h45 - LOW	Workshop container S3/h63 - HIGH	Workshop container S4/h45 - LOW	Workshop container S4/h63 - HIGH	Workshop container S5/h45 - LOW	Workshop container S5/h63 - HIGH
Code	YMIN392	YMIN393	YMIN394	YMIN395	YMIN396	YMIN397	YMIN398	YMIN399	YMIN340	YMIN341
Dimension height x width x depth	45 x 54 x 54 mm	63 x 54 x 54 mm	45 x 54 x 108 mm	63 x 54 x 108 mm	45 x 108 x 108 mm	63 x 108 x 108 mm	45 x 108 x 162 mm	63 x 108 x 162 mm	45 x 108 x 216 mm	63 x 108 x 216 mm
Description	made of plastic		made of plastic							



Designation	WWT Bin	Metal container A do WWT	Metal container B do WWT	Paper bowel towel	Movable shelf to the drawer WWT
Code	XWWT 04050402	XWWT 03030302	XWWT 03040302	XWWT 02020202	XWWT 06070802
Dimension height x width x depth	145 x 350 x 110/176	70 x 200 x 80	70 x 350 x 80	85 x 350 x 185	
Description					Movable shelf to the drawer WWT covered with microrubber





# WORKSHOP FURNITURE

## ACCESSORIES

WWT accessory				
Designation	A70 Metal partition		A95 Metal partition	A145 Metal partition
Code	XWWT 05060503		XWWT 05060603	XWWT 05060703
Description	Partition's height – 70 mm Number of rows – 2 wide		Partition's height – 95 mm Number of rows – 2 wide	Partition's height – 145 mm Number of rows – 2 wide

WWT accessory				
Designation	B70 Metal partition		B95 Metal partition	B145 Metal partition
Code	XWWT 05060504		XWWT 05060604	XWWT 05060704
Description	Partition's height – 70 mm Number of rows – 4 narrow		Partition's height – 95 mm Number of rows – 4 narrow	Partition's height – 145mm Number of rows – 4 narrow

WWT accessory				
Designation	C70 Metal partition		C95 Metal partition	C145 Metal partition
Code	XWWT 05060505		XWWT 05060605	XWWT 05060705
Description	Partition's height – 70 mm Number of rows – 2 wide + 1 narrow		Partition's height – 95 mm Number of rows – 2 narrow + 1 wide	Partition's height – 145 mm Number of rows – 2 narrow + 1 wide

# WORKSHOP FURNITURE

## CABINETS FOR INDUSTRIAL COMPUTER

Perfect solution for factories to store industrial computers.

### SPNK

The cabinet has a flat structure of minimum depth. The front screen is adapted to assembly 16:9 LCD screen and of maximum 22 inches diagonal.

The resistance class, supported with examinations IP-42, ensure protection of the cabinet against foreign objects of over 1 mm size, and protection against drops of water falling down on the casing at the angle of 15 degrees.

The unscrewed base of the cabinet enables screwing the cabinet directly to ground.

Rich equipment as standard: a fan, a power supply, a service wire, and a power strip with the antiinterference filter.

### SMK

The upper glass part for LCD screen allows to use equipment even if there is dust on the factory floor.

The bottom covered part serves for safe-keeping of the computer and other devices.

Extendable shelf allows for using the keyboard easily and comfortably. The cabinet has legs with possibility of leveling what allows to put it on each kind of floor, even the uneven one.

The cabinet is equipped with inner electric fan that cools the working computer. In the bottom part of the cabinet there is a powering anti-interference slat. Back side has ventilation holes in it.

The adjustable shelf makes it possible to set its height depending on kind of computer kept in the cabinet.



248



SmKa

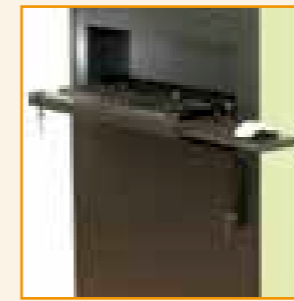

#### Computer protection

Protection against dust and water, accidental damage and unauthorized access – IP 42 resistance class.



#### Stability

The unscrewed base of the cabinet enables screwing the cabinet directly to ground.

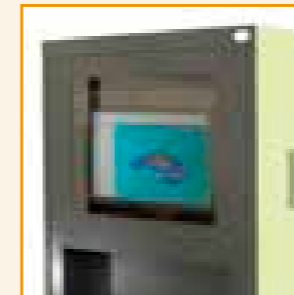

#### Functionality

The 4:3 front screen is adapted to assembly 16:9 LCD screen and of maximum 22 inches diagonal.



#### Wide range of accessories

Standard equipment: 2 shelves on latches, 1 extendable shelf for a computer, a fan, a power strip with the antiinterference filter, Ethernet loop, power strip, a handle for LCD screen, doors with a lock with patent filler – 3 point locking, Place for a keyboard closed with a cylindrical lock – locking in 1 point.

## TECHNICAL SPECIFICATION

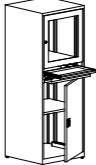
Industrial computer cabinet					
		SmK	SmKa	SmK1	SmK1a
Designation	SPNK	SMK 0101010201	SMK 0101010202	SMK 0101010101	SMK 0101010102
Code	SMK0506050506				
Height (mm)	1770	1750			
Width (mm)	755	640			
Depth (mm)	330	630			
Equipment	Cabinet equipped with: - a fan, - a power strip, - a terminal, - a power strip with the anti-interference filter.	The keyboard protecting part opens together with the main door. The cabinet with equipment: a fan and a power strip.	The keyboard protecting part opens separately. The cabinet with equipment: a fan and a power strip.	The keyboard protecting part opens together with the main door. The cabinet without any additional equipment.	The keyboard protecting part opens separately. The cabinet without any additional equipment.

# WORKSHOP FURNITURE

## INDUSTRIAL COMPUTER CABINET



### SMK 3A

Cabinets are equipped with the drawer for a keyboard and extendable shelf in the bottom compartment. On the side walls the cabinet has a ventilation. In the back wall of the cabinet there are holes for the power supply. Glass screen made of the tempered glass. The cabinet equipped with levelling feet.

### SMK 4A

Industrial computer cabinet – the glass part is adapted for the depth of the LCD screen. Extendable shelf allows for using the keyboard easily and comfortably. The back side has ventilation holes in it. The adjustable shelf makes it possible to set its height depending on the kind of computer kept in the cabinet.

### SMK 2

Industrial computer cabinet made of 0.8 mm thick steel sheet. There is one door at the entire height. A shelf for the LCD screen is fixed, other shelves can be adjusted every 25 mm. The cabinet can store LCD screen of size up to 17 inches. The cabinet is equipped with a fixed shelf for a keyboard and a mouse (assembly at customer's place), a fan, a power strip with 4 sockets.

### SMK 3A



### SMK 4A



### SMK 2

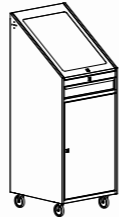
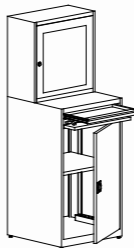
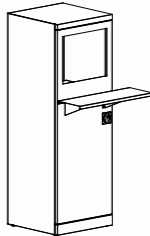

## TECHNICAL SPECIFICATION

Industrial computer cabinet							
	Designation	SmK 3A	SmK 3A	SmK 4a	SmK 4a	SmK 2	
Code	SMK 0405010104	SMK 0405010204	SMK 0101010105	SMK 0101010205	SMK 0202030203		
Height (mm)	1545		1750		1600		
Width (mm)	640		640		550		
Depth (mm)	635		630		550		
Equipment	Electric equipment not included. Equipped with: – keyboard shelf, – sliding shelf in the lower compartment, – ventilation on the sides, – holes for the wires at the back of the locker.		Electric with wiring system equipped with: – keyboard shelf, – sliding shelf in the lower compartment, – ventilation on the sides, – holes for the wires at the back of the locker.		Cabinet equipped with: - keyboard protecting part, - adjustable shelf, - fan, - power strip.	Cabinet equipped with: - keyboard protecting part, - adjustable shelf.	Cabinet equipped with: - fixed shelf for a keyboard and a mouse (assembly at customer's place), - fan, - power strip with 4 sockets.

# MOVABLE SHELVING SYSTEM

*Furniture  
you can depend on*



## TABLE OF CONTENTS

LITREG crank driven movable shelving system

254

Movable shelving system with SOFT TOUCH electric drive

260

# MOVABLE SHELVING SYSTEM

## LITREG CRANK DRIVEN MOVABLE SHELVING RACKS

### WE UNDERSTAND THE NEEDS

We understand your need for furnishing offices, archives and libraries. We offer movable shelving racks. It is an ideal solution for documents archiving and storing, as it gives unlimited possibilities and allows to use archival area at maximum.

### WE GUARANTEE THE FUNCTIONALITY

Wide range of the equipment possibilities ensure effective use of even the smallest space. Additional equipment: frame, extendable drawers, shelves and supports for documents ensure effective work.

### WE ENSURE THE SATISFACTION

We will present our offer on your every enquiry. We will design a plan of developing an archive, a warehouse or an office with bookshelves at no extra cost, proposing the most advantageous solutions. Together we will create the optimal solution for efficient use of rooms.



### VARIOUS SOLUTIONS



### MEDALIST SHELVING



open shelving



shelving with sliding doors



shelving with winged doors



closing shelving rack



# MOVABLE SHELVING SYSTEM

## 'LITREG' CRANK DRIVEN MOVABLE SHELVING SYSTEM



Extendable frame drawer  
- an easy access to files.



Extendable shelf  
- ensures comfort of use.



Book support - for  
comfortable use and  
organized files.



Crank mechanism with  
blockade - safe manual.

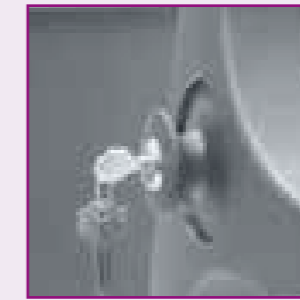

Crank mechanism with  
blockade with a lock -  
additional security.

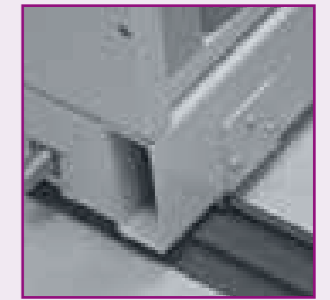

Solid frame bearer  
guarantees stability and  
durability.

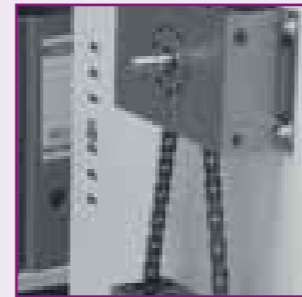

Solid crank mechanism  
- big transmission,  
easy to move.



Adjustable shelves  
- guarantee flexibility of  
shelving racks.



Strengthening cross bar  
- ensures stability and  
stiffness of shelving rack's  
construction.

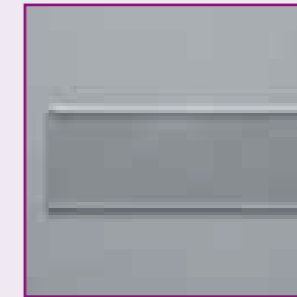

Frame with card holder  
- allows for proper  
organization of documents.



Embedded trackage.



Surface trackage.

We offer solutions that adapt to people's needs and guarantee functionality, dynamics, efficiency of use and friendly atmosphere.

It is possible to adjust height of a shelving and width of shelves according to customer needs.



Mesh panel system - for  
safe paintings storage.

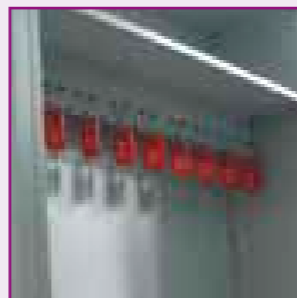

Wardrobe rack  
- wide range of use.

## TECHNICAL SPECIFICATION

Height (mm)	2019		2394	
Shelf's width (mm)	1000		750	
Shelf's depth (mm)	250	300	350	370
Shelves per unit	5 or 6 shelves + 1 top shelf as a cover			
Distance between shelves	350 mm			
Shelf's adjustment	every 25 mm			
Loading capacity	40 kg		80 kg - (option)	
Distance buffers	20 mm thick			
Drive	Crank driven			
Additional equipment	- shelf's partitions - a lock - a blockade - full and frame drawers for hanging files (only for 370 mm deep shelf) - extendable shelves - mesh panel system-wardrobe rack			

# MOVABLE SHELVING SYSTEM

## LITREG CRANK DRIVEN MOVABLE SHELVING SYSTEM



3D Model  
400 running metres of shelving

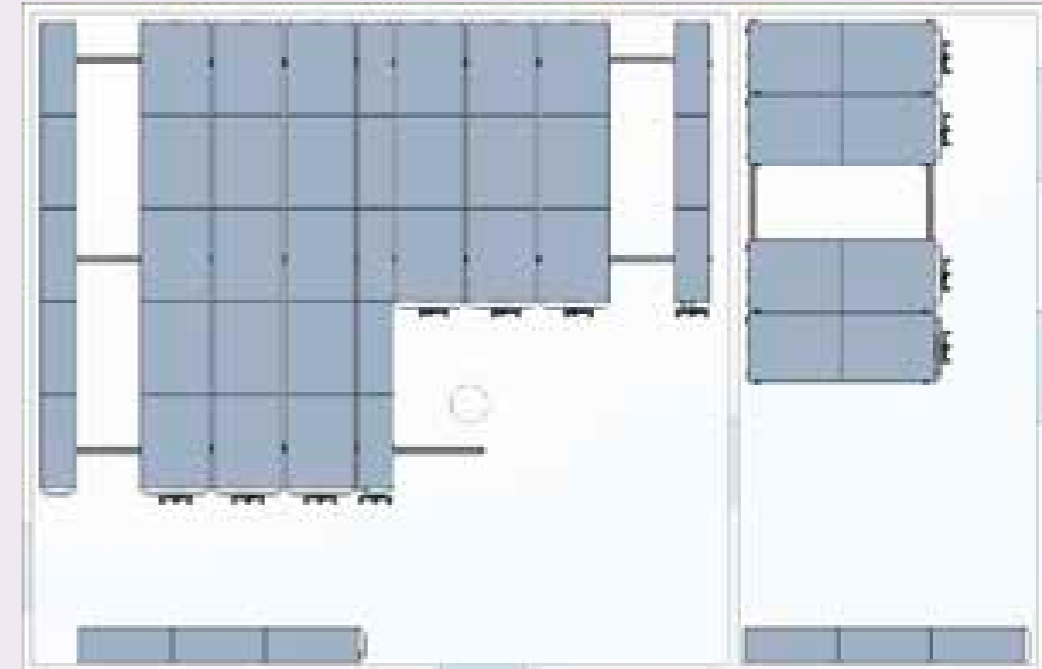

furnishing project  
400 running metres of shelving

### ECONOMY OF SPACE

Standard shelving allows to store only 1040 binders.

By applying LITREG CRANK DRIVEN MOVABLE SHELVING SYSTEM it is possible to double the storage place.

Furnishing the same area with our movable shelving allow to store 2080 binders.

Because of individual technical conditions and customer's requirements, we provide you with a project together with estimated cost only after receiving information about available space and requirements.

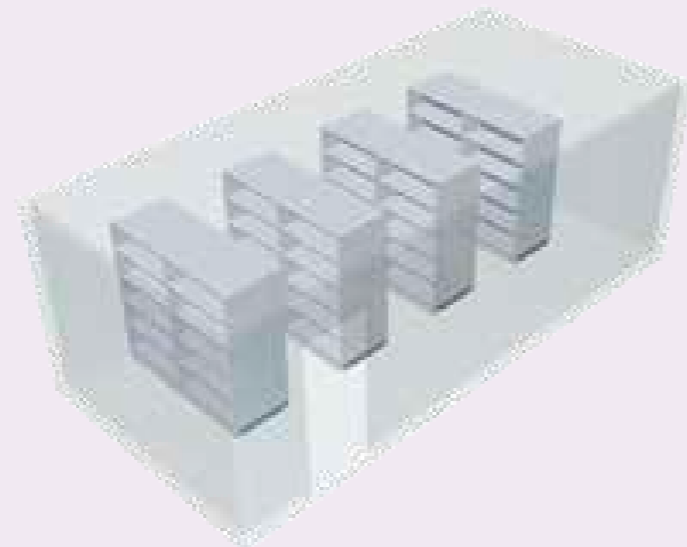

stationary shelving  
80 running metres - ca. 1040 binders



movable shelving racks  
160 running metres - ca. 2080 binders

# MOVABLE SHELVING SYSTEM

MOVABLE SHELVING SYSTEM  
WITH SOFT TOUCH  
ELECTRIC DRIVE

## MODERN SYSTEM

The movable shelving racks with SOFT TOUCH system is a truly innovative solution. Moving particular units no longer requires any physical effort. Tap gently in specific spot to access required archives. This is a perfect solution for large and often used archives, when user is carrying documents and is not able to use his hands, and especially for disabled people. Shelving rack move smoothly, what protects files against changing their position during the move.



## VARIOUS SOLUTIONS



## MEDALIST SHELVING



shelving rack with  
sliding doors



shelving rack  
with shelves



shelving rack  
with mesh panel

## MOVABLE SHELVING SYSTEM

### MOVABLE SHELVING SYSTEM WITH SOFT TOUCH ELECTRIC DRIVE



The trackage is galvanized. The total height of the track is 12 mm. Trackage is anchored to the floor with expansion bolts. The outermost tracks have an anti-tilt system, protecting against overturning. Optimally selected number of rails ensures smooth and easy movement of units. There is also a possibility of installing a chain in the trackway.

### SHELVING'S FUNCTIONS

Movable shelving system provide possibility of transmission by means of following elements: electric motor and cogwheels coupled with transmission shaft.

The control system has following functions:

- opening,
- blocking,
- resetting,
- failure alarm,
- moving apart, airing,
- user protection, safety.



### FRAME CHASSIS

The frame is made of powder coated steel profiles coloured in RAL 7035. The frame is equipped with shafts and cast iron wheels. The wheels have ball bearing to improve the quality of use. The frames are equipped with rubber distance buffers in order to prevent units from sliding off. Movable shelving system provide the possibility of transmission by means of following elements: electric motor, cogwheels coupled with transmission shaft.

### LOAD-BEARING WALL



The load-bearing wall is made of powder coated steel sheet and perforated every 25 mm (either in intervals or continuously). Thus shelves can be adjusted at any desired height. For additional rigidity of units, a cross-wise strengthening is applied.

## MOVABLE SHELVING SYSTEM

### MOVABLE SHELVING SYSTEM WITH SOFT TOUCH ELECTRIC DRIVE

Movable shelving system with 'SOFT TOUCH' electric drive combines features of archiving huge stocks of documentation with the best customer service.



Shelves are made of powder coated steel and are equipped with a shelves' dividers, what prevent documents from moving on neighbouring shelf. Shelf's loading capacity is 40 kg or 80 kg (as an option). The front wall from the side of control panel, is covered with a decorative panel.



## SAFETY



The shelving is designed with a possibility of locking with special keys. The access to particular units might be restricted only to employees possessing a particular key. The shelving also have in-built 'night positioning' option. All units slide in equal distance to each other so as to provide additional ventilation. Units are equipped with electric overload protection, that reacts to all obstacles while moving. Additionally, the shelving is equipped with a passive safety system. The system forces users to have a look at an opened alley, before it moves to another. All the functions guarantee safety of use.

# MOVABLE SHELVING SYSTEM

## MOVABLE SHELVING SYSTEM WITH SOFT TOUCH ELECTRIC DRIVE

Movable shelving system with modern electric propulsion. The control panel and the entire mechanism of the electric drive are fine-tuned in every detail, with the greatest safety consciousness and comfort of the user.



Movement of the system is held through the control panel placed on the front wall of each unit. It is possible to move all units with one control unit. Control panel indicate the direction of movement and opening of a corridor. Opening and closing of a particular unit comes down just to press the button on the control panel. The panel is equipped with the system of signal diodes, informing about the system failure. Additional control program is detecting and signalling the place and the kind of a breakdown.

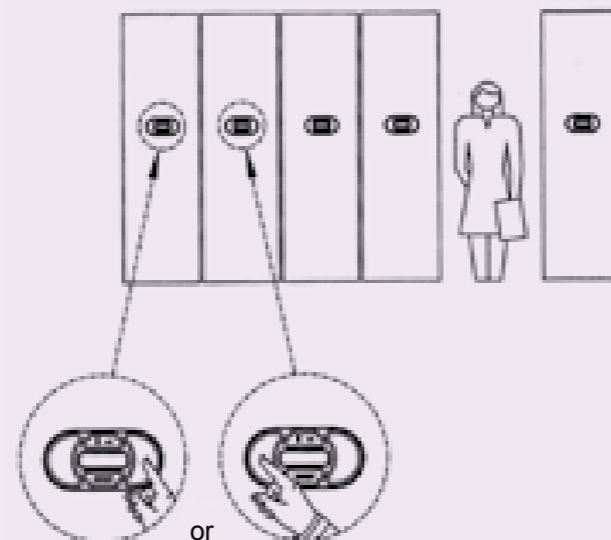
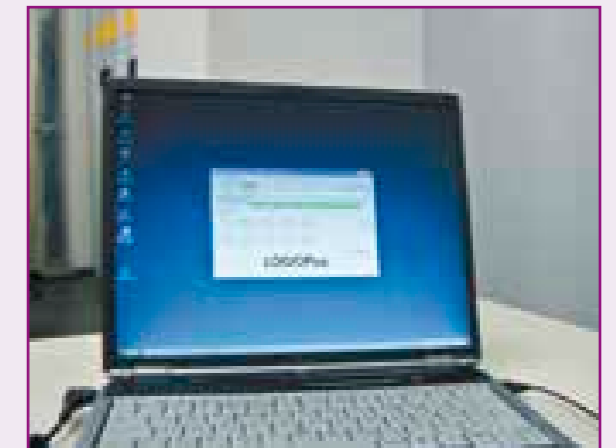

The units are moved with the control panel.



Wiring placed in cable channels put on the top of the unit- as shoulders between elements.



# MOVABLE SHELVING SYSTEM

## MOVABLE SHELVING SYSTEM WITH SOFT TOUCH ELECTRIC DRIVE

It is possible to adjust the height, the interspace of shelves and to fit solutions to individual needs of users.



Lighting of the space between units. The illumination is controlled electronically and works only above the unit currently used by a personnel. Lighting covers are placed on metal trusses, screwed to the top shelves (the covering). The illumination starts automatically when the alley is opened and switches off when it is closed, provided software allow user to set the time after which the light switches off.



Mesh panel system for safe storage of images.



Pull-out frame drawers facilitate access to documents.



### SOFT TOUCH SYSTEM TECHNICAL SPECIFICATION

Height (mm)	2019	2394
Shelf's width (mm)	1000	750
	or set individually	
Shelf's depth (mm)	300	
Number of shelves	5 or 6 shelves + 1 covering shelf (dust cover)	
Distance between shelves	350 mm or set individually	
Shelf's adjustment	every 25 mm	
Shelf's load capacity	40 kg	80 kg (option)
Distance buffers	20 mm thick	
Drive	Electric	
Additional equipment	- shelf's dividers - lightning - pull-out frame drawers - mesh panels	



RAL 9010



RAL 1015



RAL 7032



RAL 8016

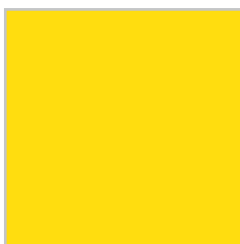

RAL 1023



RAL 2004

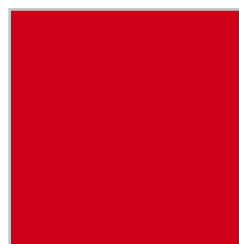

RAL 3020

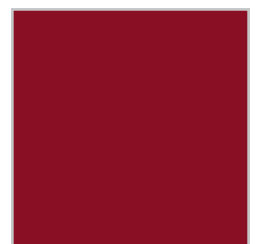

RAL 3005



RAL 6011

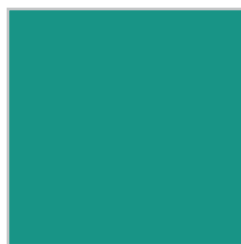

RAL 6033

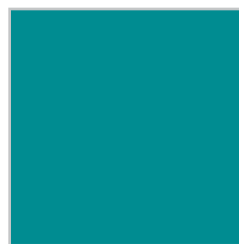

RAL 5018

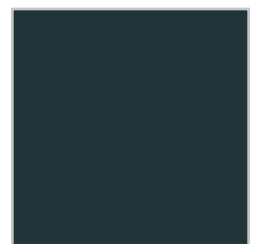

RAL 7016

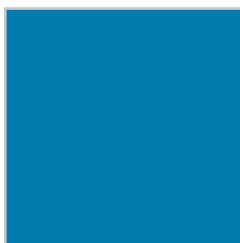

RAL 5012



RAL 5010



RAL 7035

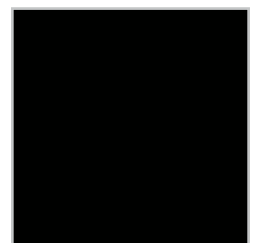

RAL 9005

The only purpose of this table is to show the colours roughly. For more accurate view please see full RAL colours palette. We reserve the right to possibility of occurring insignificant differences from the given colours, what should not be a reason of any complaints.

We also reserve the right to implement construction changes in our production, what can have insignificant influence on the product appearance.

Colours of products shown in the photographs in the catalogue and the visualisations have demonstrative character only and may differ from the colours of the offered products.



**AKD s.r.o.**

Bratislavská 82/16

92 401 GALANTA

[www.akdsro.sk](http://www.akdsro.sk)

[akdsro@akdsro.sk](mailto:akdsro@akdsro.sk)

mob.: +4219 11 600 625

tel.: 031 701 24 29

